

Part Specifications with Approved Suppliers

Line Slot: PFG Uncharted Fleece Full Zip State: Production Season: F24
 Merchandise Division: Sportswear Merchandise Collection: PFG Product Class: Fleece FZ
 Designer: mdavis Developer: cdemmitt LO Developer: kgokul Sourcing Manager: melissa.gallagher
 Fit Engineer: kicampbell



Design: F4MS209661 Sample LO: India Production LO: India Vendor Master: INDIA Vendor Master: INDIA
 Style: Material Style Style Description Pattern Base Size Size Scale Fit SMU Type
 FO9344 2096611 PFG Uncharted™ Fleece Full Zip M24M3095 M XS - XXL Active N/A

Number	Description	UM	Fiber Content	Fiber Content Back	Material Coating	Material Finish (Face)	Material Laminate	Trim Specific	Supplier Art No	Country of Origin	Standard Cost (FOB)	Purchase Cost (CIF)	Product on Lead Time with Greige	Product on Lead Time without Greige
002614	Plastic Washer (Polyurethane) (use on all Snap Stud and Post or Eyelets if needed) Clear	ea	100% Polyurethane	unassigned	unassigned	unassigned	unassigned	Size UM: mm						
Unitex International Button Accessories Ltd									002614	China	0.00592	0.0	28	40
FGV Sourced									002614	unassigned	0.0	0.0	0	0
Button International Company									002614	Taiwan	0.0013	0.0	35	40
004611	5/8 in Grosgrain Tape, Poly 1 clr	yd	100% Polyester	unassigned	unassigned	unassigned	unassigned	Size UM: mm						
Gong Myung Korea									GM-4611	South Korea	0.115	0.0	30	30
Paiho Global									004611	Taiwan	0.122	0.0	30	60
Naturub Group of Companies									BND019569	Bangladesh	0.082	0.0	30	45
360183	3/4 in W Foldover (3/8 to show) Woven Stretch Binding 1 clr FOR CAN STYLES PRODUCED IN VN use 110808	yd	86% Nylon, 14% Elastane	unassigned	unassigned	unassigned	unassigned	Size UM: mm Width: 0.75						
Sun Hod Enterprise Co Ltd (formerly Sang Hsin)									360183	Taiwan	0.14	0.168	30	30
Gong Myung Korea									360183	South Korea	0.145	0.163	30	30
Paiho Global									360183	Taiwan	0.16	0.0	30	60
Naturub Group of Companies									BLD-002550	Bangladesh	0.1369	0.0	12	28
360027	3/8 in Grosgrain Tape Poly 1 clr	yd	100% Polyester	unassigned	unassigned	unassigned	unassigned	Size UM: mm Width: 9.5						
Gong Myung Korea									360027	South Korea	0.068	0.0	30	30
Paiho Global									360027	Taiwan	0.068	0.0	30	60
Naturub Group of Companies									BND017368	Bangladesh	0.0636	0.0	30	45
FGV - Shahi Exports Pvt. (SEP) Ltd.									360027	India	0.0595	0.0	18	25
126810	CFOL-36 DAV3 E P12 TO-IPOM REVERSE OpenEnd Left-in AutoLk Enml Sldr/PI RevCoil	ea	unassigned	unassigned	unassigned	unassigned	unassigned	Size UM: ea Length: 8.0						
Ideal Fastener Global									IE-NSFUOL36 N36 IP32	unassigned	0.4643	0.0	21	28

Color BOM

Line Slot: PFG Uncharted Fleece Full Zip		State: Production		Season: F24			
Merchandise Division: Sportswear		Merchandise Collection: PFG		Product Class: Fleece FZ			
Designer: mdavis		Developer: cdemmitt		LO Developer: kgokul			
Fit Engineer: kicampbell				Sourcing Manager: melissa.gallagher			
Design:	F4MS209661	Sample LO:	India	Production LO:	India		
Style	Material Style	Style Description	Pattern	Base Size	Size Scale	Fit	SMU Type
FO9344	2096611	PFG Uncharted™ Fleece Full Zip	M24M3095	M	XS - XXL	Active	N/A



Component	Details	Placement	Usage	Width	Marker Width	011-Shark, Shark	012-Shark, Dark Stone	254-Iron, Iron	316-Cypress, Cypress
SAP Material Code						2096611011	2096611012	2096611254	2096611316
SMU Accounts						N/A	N/A	N/A	N/A
Shell 1	110452 Recycled Solid Version Of Fast Trek Fleece (011604) Fleece 100% Recycled Polyester 19 Anti-pill (face), Brushed (Tech Back) MaterialCoatingNone MaterialLaminateNone 250.0 g/m2 Piece Dye/Jet NA		1.48 yd	60.0	0	Shark	Dark Stone	Iron	Cypress
Shell 2	119422 PFC Free Version of 101215 Back Country Cloth II Textured Taffeta 100% Tactel® Nylon 114x80 78D/34Fx156D/102F Water Repellent (80/5HL) C0 PFOA/PFOS Free MaterialCoatingNone MaterialLaminateNone 105.0 g/m2 Piece Dye/Jet NA		1.5 yd	56.0	0	Shark	Shark	Iron	Cypress
Interfacing 1	012175 Interlining Woven Fusible Lightweight With Stretch Interlining 100% Polyester 31.0 g/m2		0.15 yd	60.0	0	White	White	White	White
Drawcord-Cording-Laces 1	108098 2.2mm Stretch drawcord with 1 tick		1.55 yd	0.0	0	Black, Grill	Black, Grill	Grill, Columbia Grey	Grill, Columbia Grey
Elastic 1	340001 1 in Woven Elastic. Black and White only 1 clr. FOB price is for white only FOR CAN STYLES PRODUCED IN VN use 110897 Width: 1.0		0.6 yd	0.0	0	White	White	White	White
Eyelets-Grommets 1	062429 5mm ID/11mm OD rubber coated eyelet Same as 061839. 1 clr		1 set	0.0	0	Black	Black	Grill	Grill

Color BOM

Line Slot: PFG Uncharted Fleece Full Zip	State: Production	Season: F24
Merchandise Division: Sportswear	Merchandise Collection: PFG	Product Class: Fleece FZ
Designer: mdavis	Developer: cdemmitt	LO Developer: kgokul
Fit Engineer: kicampbell		Sourcing Manager: melissa.gallagher
Design: F4MS209661	Sample LO: India	Production LO: India
Style: Material Style	Style Description: Pattern	Base Size: Size Scale
FO9344: 2096611	PFG Uncharted™ Fleece Full Zip	M: XS - XXL
		Fit: Active
		SMU Type: N/A



Component	Details	Placement	Usage	Width	Marker Width	011-Shark, Shark	012-Shark, Dark Stone	254-Iron, Iron	316-Cypress, Cypress
SAP Material Code						2096611011	2096611012	2096611254	2096611316
Label Logo 1	125978 PFG 52mm silicone print on satin woven base		1 ea	0.0	0	Cool Grey, Grill	Cool Grey, Grill	Cool Grey, Grill	Cool Grey, Grill
Label Logo 2	125981 PFG 51mm raised printed triangle logo woven label		1 ea	0.0	0	Cool Grey, Grill	Cool Grey, Grill	Cool Grey, Grill	Cool Grey, Grill
Label Logo 3	059197 USE ONLY FOR ALL ADULTSIZES AND YOUTH S-XL 42mm x 8mm Lightweight Stripe woven ECO Hanger Loop DOWN 2 clr other colors w Director approval only		1 ea	0.0	0	Columbia Grey, Grill	Columbia Grey, Grill	Columbia Grey, Grill	Columbia Grey, Grill
Phero 1	105916 1.2mm ticked d/c with soft rubber textured phemo (Short) Call out Base color d/c, Tick color, Rubber		4 ea	0.0	0	Black, Grill, Black	Black, Grill, Black	Grill, Columbia Grey, Black	Grill, Columbia Grey, Black
Thread 1	008214 Coats ASTRA Spun Polyester Tex 27 40/2		620 meter	0.0	0	DTM	DTM	DTM	DTM
Thread 2	110529 Coats Astra spun Polyester Tex 30		58 meter	0.0	0	DTM	DTM	DTM	DTM
Toggle 1	108106 2 hole barrel toggle with 2 functioning ends for 1.5/2.2 d/c		1 ea	0.0	0	Grill	Grill	Grill	Grill
Washer 1	002614 Plastic Washer (Polyurethane) (use on all Snap Stud and Post or Eyelets if needed) Clear		2 ea	0.0	0	Clear	Clear	Clear	Clear
Webbing and Tape 1	004611 5/8 in Grosgrain Tape, Poly 1 clr		0.89 yd	0.0	0	Grill	Grill	Grill	Grill
Webbing and Tape 2	360183 3/4 in W Foldover (3/8 to show) Woven Stretch Binding 1 clr FOR CAN STYLES PRODUCED IN VN use 110808 Width: 0.75		1.85 yd	0.0	0	Shark	Dark Stone	Iron	Cypress
Webbing and Tape 3	360027 3/8 in Grosgrain Tape Poly 1 clr Width: 9.5		1.85 yd	0.0	0	Black	Black	Grill	Grill
Zipper 1	126810 CFOL-36 DAV3 E P12 TO-IPOM REVERSE OpenEnd Left-in AutoLk Enml Sldr/PI RevCoil Length: 8.0		1 ea	0.0	0	Shark	Dark Stone	Iron	Cypress

Color BOM

Line Slot: PFG Uncharted Fleece Full Zip	State: Production	Season: F24
Merchandise Division: Sportswear	Merchandise Collection: PFG	Product Class: Fleece FZ
Designer: mdavis	Developer: cdemmitt	LO Developer: kgokul
Fit Engineer: kicampbell		Sourcing Manager: melissa.gallagher
Design: F4MS209661	Sample LO: India	Production LO: India
Style: Material Style	Style Description: Pattern	Base Size: Size Scale
FO9344: 2096611	PFG Uncharted™ Fleece Full Zip	M: XS - XXL
		Fit: Active
		SMU Type: N/A



Component	Details	Placement	Usage	Width	Marker Width	011-Shark, Shark	012-Shark, Dark Stone	254-Iron, Iron	316-Cypress, Cypress
SAP Material Code						2096611011	2096611012	2096611254	2096611316
Zipper 2	126123 CFC-36 DA E B-E Clsd AutoLk Enml Slidr/PI EnmlBtmStp Length: 4.0		1 ea	0.0	0	Shark	Dark Stone	Iron	Cypress
Zipper 3	126123 CFC-36 DA E B-E Clsd AutoLk Enml Slidr/PI EnmlBtmStp Length: 4.0		2 ea	0.0	0	Shark	Dark Stone	Iron	Cypress
Label 1	059199 40mm CSC Main /International ECO Size Woven Loop Label 3 clr		1 ea	0.0	0	White, Columbia Grey, Compass Blue	White, Columbia Grey, Compass Blue	White, Columbia Grey, Compass Blue	White, Columbia Grey, Compass Blue
Label 2	006564 33mm Care Content ECO Booklet Fold label with fully translated country of origin WHT/BLK for most, BLK/WHT for Titanium only, GRY/BLK is for Garment DYE ONLY		1 ea	0.0	0	White, Black	White, Black	White, Black	White, Black
Hangtag Package Part	097308 PFG No Tech Hangtag		1 ea	0.0	0	Artwork	Artwork	Artwork	Artwork
Hangtag Package Part	121612 MSRP/UPC with RFID Specs for MSRP. Please refer to VAS specs for any exceptions. MSRP required on all product shipping to the US.		1 ea	0.0	0	Artwork	Artwork	Artwork	Artwork
Hangtag Package Part	126966 Active Fit Swing Tag		1 ea	0.0	0	Artwork	Artwork	Artwork	Artwork
Packaging 1	980001 Polybag See Standard CCS 4200 for specifications		1 ea	0.0	0	Stock	Stock	Stock	Stock
Packaging 2	980010 UPC Bag Sticker Generic (MHW/Columbia) See CCS4400/ 4401 and MHW4402 for Mt Hardware for instructions		1 ea	0.0	0	Artwork	Artwork	Artwork	Artwork

This is confidential and proprietary information of Columbia Sportswear Company. You agree that you will not disclose this information to any third party or use it for any purpose other than on behalf of Columbia. You have no right to use Columbia's name or any of its trademarks, trade names, copyrights, patents, designs or other intellectual property except as set forth in writing by Columbia.

Color BOM

Line Slot: PFG Uncharted Fleece Full Zip

State: Production

Season: F24

Merchandise Division: Sportswear

Merchandise Collection: PFG

Product Class: Fleece FZ

Designer: mdavis

Developer: cdemmitt

LO Developer: kgokul

Sourcing Manager: melissa.gallagher

Fit Engineer: kicampbell

Design: F4MS209661

Sample LO: India

Production LO: India

Style Material Style

Style Description Pattern

Base Size Size Scale

Fit SMU Type

FO9344 2096611

PFG Uncharted™ M24M3095
Fleece Full Zip

M XS - XXL

Active N/A



Colorless BOM



Line Slot: PFG Uncharted Fleece Full Zip State: Production Season: F24
 Merchandise Division: Sportswear Merchandise Collection: PFG Product Class: Fleece FZ
 Designer: mdavis Developer: cdemmitt LO Developer: kgokul Sourcing Manager: melissa.gallagher
 Fit Engineer: kicampbell
 Design: F4MS209661 Sample LO: India Production LO: India
 Style: Material Style Style Description Pattern Base Size Size Scale Fit SMU Type
 FO9344 2096611 PFG Uncharted™ Fleece Full Zip M24M3095 M XS - XXL Active N/A

Component	Details	Placement	Usage	Width	Marker Width
SAP Material Code					
Shell 1	110452 Recycled Solid Version Of Fast Trek Fleece (011604) Fleece 100% Recycled Polyester 19 Anti-pill (face), Brushed (Tech Back) MaterialCoatingNone MaterialLaminateNone 250.0 g/m2 Piece Dye/Jet NA		1.48 yd	60.0	0
Shell 2	119422 PFC Free Version of 101215 Back Country Cloth II Textured Taffeta 100% Tactel® Nylon 114x80 78D/34Fx156D/102F Water Repellent (80/5HL) C0 PFOA/PFOS Free MaterialCoatingNone MaterialLaminateNone 105.0 g/m2 Piece Dye/Jet NA		1.5 yd	56.0	0
Interfacing 1	012175 Interlining Woven Fusible Lightweight With Stretch Interlining 100% Polyester 31.0 g/m2		0.15 yd	60.0	0
Drawcord-Cording-Laces 1	108098 2.2mm Stretch drawcord with 1 tick		1.55 yd	0.0	0
Elastic 1	340001 1 in Woven Elastic. Black and White only 1 clr. FOB price is for white only FOR CAN STYLES PRODUCED IN VN use 110897 Width: 1.0		0.6 yd	0.0	0
Eyelets-Grommets 1	062429 5mm ID/11mm OD rubber coated eyelet Same as 061839. 1 clr		1 set	0.0	0
Label Logo 1	125978 PFG 52mm silicone print on satin woven base		1 ea	0.0	0
Label Logo 2	125981 PFG 51mm raised printed triangle logo woven label		1 ea	0.0	0
Label Logo 3	059197 USE ONLY FOR ALL ADULT sizes AND YOUTH S-XL 42mm x 8mm Lightweight Stripe woven ECO Hanger Loop DOWN 2 clr other colors w Director approval only		1 ea	0.0	0
Phero 1	105916 1.2mm ticked d/c with soft rubber textured phero (Short) Call out Base color d/c, Tick color, Rubber		4 ea	0.0	0
Thread 1	008214 Coats ASTRA Spun Polyester Tex 27 40/2		620 meter	0.0	0
Thread 2	110529 Coats Astra spun Polyester Tex 30		58 meter	0.0	0

Colorless BOM



Line Slot: PFG Uncharted Fleece Full Zip State: Production Season: F24
 Merchandise Division: Sportswear Merchandise Collection: PFG Product Class: Fleece FZ
 Designer: mdavis Developer: cdemmitt LO Developer: kgokul Sourcing Manager: melissa.gallagher
 Fit Engineer: kicampbell
 Design: F4MS209661 Sample LO: India Production LO: India
 Style: Material Style Style Description Pattern Base Size Size Scale Fit SMU Type
 FO9344 2096611 PFG Uncharted™ Fleece Full Zip M24M3095 M XS - XXL Active N/A

Component	Details	Placement	Usage	Width	Marker Width
SAP Material Code					
Toggle 1	108106 2 hole barrel toggle with 2 functioning ends for 1.5/2.2 d/c		1 ea	0.0	0
Washer 1	002614 Plastic Washer (Polyurethane) (use on all Snap Stud and Post or Eyelets if needed) Clear		2 ea	0.0	0
Webbing and Tape 1	004611 5/8 in Grosgrain Tape, Poly 1 clr		0.89 yd	0.0	0
Webbing and Tape 2	360183 3/4 in W Foldover (3/8 to show) Woven Stretch Binding 1 clr FOR CAN STYLES PRODUCED IN VN use 110808 Width: 0.75		1.85 yd	0.0	0
Webbing and Tape 3	360027 3/8 in Grosgrain Tape Poly 1 clr Width: 9.5		1.85 yd	0.0	0
Zipper 1	126810 CFOL-36 DAV3 E P12 TO-IPOM REVERSE OpenEnd Left-in AutoLk Enml Sldr/PI RevCoil Length: 8.0		1 ea	0.0	0
Zipper 2	126123 CFC-36 DA E B-E Clsd AutoLk Enml Sldr/PI EnmlBtmStp Length: 4.0		1 ea	0.0	0
Zipper 3	126123 CFC-36 DA E B-E Clsd AutoLk Enml Sldr/PI EnmlBtmStp Length: 4.0		2 ea	0.0	0
Label 1	059199 40mm CSC Main /International ECO Size Woven Loop Label 3 clr		1 ea	0.0	0
Label 2	006564 33mm Care Content ECO Booklet Fold label with fully translated country of origin WHT/BLK for most, BLK/WHT for Titanium only, GRY/BLK is for Garment DYE ONLY		1 ea	0.0	0
Hangtag Package Part	097308 PFG No Tech Hangtag		1 ea	0.0	0
Hangtag Package Part	121612 MSRP/UPC with RFID Specs for MSRP. Please refer to VAS specs for any exceptions. MSRP required on all product shipping to the US.		1 ea	0.0	0
Hangtag Package Part	126966 Active Fit Swing Tag		1 ea	0.0	0
Packaging 1	980001 Polybag See Standard CCS 4200 for specifications		1 ea	0.0	0
Packaging 2	980010 UPC Bag Sticker Generic (MHW/Columbia) See CCS4400/ 4401 and MHW4402 for Mt Hardwear for instructions		1 ea	0.0	0

This is confidential and proprietary information of Columbia Sportswear Company. You agree that you will not disclose this information to any third party or use it for any purpose other than on behalf of Columbia. You have no right to use Columbia's name or any of its trademarks, trade names, copyrights, patents, designs or other intellectual property except as set forth in writing by Columbia.

Color Specification

Line Slot: PFG Uncharted Fleece Full Zip		State: Production		Season: F24			
Merchandise Division: Sportswear		Merchandise Collection: PFG		Product Class: Fleece FZ			
Designer: mdavis		Developer: cdemmitt		LO Developer: kgokul			
Fit Engineer: kicampbell				Sourcing Manager: melissa.gallagher			
Design:	F4MS209661	Sample LO:	India	Production LO:	India		
Style	Material Style	Style Description	Pattern	Base Size	Size Scale	Fit	SMU Type
FO9344	2096611	PFG Uncharted™ Fleece Full Zip	M24M3095	M	XS - XXL	Active	N/A



Component - Material	011-Shark, Shark	012-Shark, Dark Stone	254-Iron, Iron	316-Cypress, Cypress
Shell 1 - 110452	Shark	Dark Stone	Iron	Cypress
Webbing and Tape 2 - 360183				
Zipper 1 - 126810				
Zipper 2 - 126123				
Zipper 3 - 126123	Shark	Shark	Iron	Cypress
Shell 2 - 119422				
Interfacing 1 - 012175	White	White	White	White
Elastic 1 - 340001	Black, Grill	Black, Grill	Grill, Columbia Grey	Grill, Columbia Grey
Drawcord-Cording-Laces 1 - 108098	Black	Black	Grill	Grill
Eyelets-Grommets 1 - 062429	Cool Grey, Grill	Cool Grey, Grill	Cool Grey, Grill	Cool Grey, Grill
Webbing and Tape 3 - 360027	Columbia Grey, Grill	Columbia Grey, Grill	Columbia Grey, Grill	Columbia Grey, Grill
Label Logo 1 - 125978	Black, Grill, Black	Black, Grill, Black	Grill, Columbia Grey, Black	Grill, Columbia Grey, Black
Label Logo 2 - 125981	DTM	DTM	DTM	DTM
Label Logo 3 - 059197	Grill	Grill	Grill	Grill
Phemo 1 - 105916	Clear	Clear	Clear	Clear
Thread 1 - 008214	White, Columbia Grey, Compass Blue	White, Columbia Grey, Compass Blue	White, Columbia Grey, Compass Blue	White, Columbia Grey, Compass Blue
Thread 2 - 110529	White, Black	White, Black	White, Black	White, Black
Toggle 1 - 108106	Artwork	Artwork	Artwork	Artwork
Webbing and Tape 1 - 004611				
Washer 1 - 002614				
Label 1 - 059199				
Label 2 - 006564	Stock	Stock	Stock	Stock
Hangtag Package Part - 097308				
Hangtag Package Part - 121612				
Hangtag Package Part - 126966				
Packaging 2 - 980010				
Packaging 1 - 980001				

This is confidential and proprietary information of Columbia Sportswear Company. You agree that you will not disclose this information to any third party or use it for any purpose other than on behalf of Columbia. You have no right to use Columbia's name or any of its trademarks, trade names, copyrights, patents, designs or other intellectual property except as set forth in writing by Columbia.

Costing BOM

Line Slot: PFG Uncharted Fleece Full Zip

State: Production

Season: F24

Merchandise Division: Sportswear

Merchandise Collection: PFG

Product Class: Fleece FZ

Designer: mdavis

Developer: cdemmitt

LO Developer: kgokul

Sourcing Manager: melissa.gallagher

Fit Engineer: kicampbell



Design: F4MS209661

Sample LO: India

Production LO: India

Style Material Style

Style Description Pattern

Base Size Size Scale

Fit SMU Type

FO9344 2096611

PFG Uncharted™ M24M3095
Fleece Full Zip

M XS - XXL

Active N/A

Colorway Number	Color Way	FOB Material	CIF Material	FOB Trim	CIF Trim	Allowance %	Total FOB	Total CIF
011	Shark, Shark	6.899	0.000	3.707	0.051	0.0	10.606	0.051
012	Shark, Dark Stone	6.899	0.000	3.707	0.051	0.0	10.606	0.051
254	Iron, Iron	6.899	0.000	3.707	0.051	0.0	10.606	0.051
316	Cypress, Cypress	6.899	0.000	3.707	0.051	0.0	10.606	0.051

Costing BOM

Line Slot: PFG Uncharted Fleece Full Zip

State: Production

Season: F24

Merchandise Division: Sportswear

Merchandise Collection: PFG

Product Class: Fleece FZ

Designer: mdavis

Developer: cdemmitt

LO Developer: kgokul

Sourcing Manager: melissa.gallagher

Fit Engineer: kicampbell



Design: F4MS209661

Sample LO: India

Production LO: India

Style Material Style

Style Description Pattern

Base Size Size Scale

Fit SMU Type

FO9344 2096611

PFG Uncharted™ M24M3095
Fleece Full Zip

M XS - XXL

Active N/A

Component	Material	Description	Fabric Width	Supplier	Locked	Country of Origin	Managin g Liaison Office	UoM	Target Cost	FOB Unit Cost	CIF Unit Cost	Usage	Wastage %	Total FOB	Total CIF
Shell 1	110452	Recycled Solid Version Of Fast Trek Fleece (011604)	60.0	HTT Insprite (Xiamen) Imp & Exp Co. Ltd.	N	China	Taiwan-Taipei	yd	0.0	1.9	0.0	1.480	5	2.953	0.000
Shell 2	119422	PFC Free Version of 101215 Back Country Cloth II	56.0	Formosa Taffeta Company - Zhong Shan	N	China	Taiwan-Taipei	yd	0.0	2.45	0.0	1.500	3	3.785	0.000
Interfacing 1	012175	Interlining Woven Fusible Lightweight With Stretch	60.0	PCC asia LLC	Y	China	India	yd	0.0	1.04	0.0	0.150	3	0.161	0.000
Drawcord-Cording-Laces 1	108098	2.2mm Stretch drawcord with 1 tick	0.0	Shimada Shoji (H.K.) Limited	N	China	Portland	yd	0.0	0.165	0.0	1.550	5.0	0.269	0.000

Costing BOM

Line Slot: PFG Uncharted Fleece Full Zip

State: Production

Season: F24

Merchandise Division: Sportswear

Merchandise Collection: PFG

Product Class: Fleece FZ

Designer: mdavis

Developer: cdemmitt

LO Developer: kgokul

Sourcing Manager: melissa.gallagher

Fit Engineer: kicampbell



Design: F4MS209661

Sample LO: India

Production LO: India

Style Material Style

Style Description Pattern

Base Size Size Scale

Fit SMU Type

FO9344 2096611

PFG Uncharted™ M24M3095
Fleece Full Zip

M XS - XXL

Active

N/A

Component	Material	Description	Fabric Width	Supplier	Locked	Country of Origin	Managin g Liaison Office	UoM	Target Cost	FOB Unit Cost	CIF Unit Cost	Usage	Wastage %	Total FOB	Total CIF
Elastic 1	340001	1 in Woven Elastic. Black and White only 1 clr. FOB price is for white only FOR CAN STYLES PRODUCED IN VN use 110897	0.0	Sun Hod Enterprise Co Ltd (formerly Sang Hsin)	N	Taiwan	Taiwan-Taipei	yd	0.058	0.075	0.079	0.600	7.0	0.048	0.051
Eyelets-Grommets 1	062429	5mm ID/11mm OD rubber coated eyelet Same as 061839. 1 clr	0.0	Unitex International Button Accessories Ltd	N	China	Portland	set	0.0	0.0369	0.0	1.000	3.0	0.038	0.000
Label Logo 1	125978	PFG 52mm silicone print on satin woven base	0.0	Lee Bou	N	Vietnam	Taiwan-Taipei	ea	0.0	0.37	0.0	1.000	0.0	0.370	0.000
Label Logo 2	125981	PFG 51mm raised printed triangle logo woven label	0.0	Lee Bou	N	Vietnam	Taiwan-Taipei	ea	0.0	0.43	0.0	1.000	0.0	0.430	0.000

Costing BOM

Line Slot: PFG Uncharted Fleece Full Zip

State: Production

Season: F24

Merchandise Division: Sportswear

Merchandise Collection: PFG

Product Class: Fleece FZ

Designer: mdavis

Developer: cdemmitt

LO Developer: kgokul

Sourcing Manager: melissa.gallagher

Fit Engineer: kicampbell



Design: F4MS209661

Sample LO: India

Production LO: India

Style Material Style

Style Description Pattern

Base Size Size Scale

Fit SMU Type

FO9344 2096611

PFG Uncharted™ M24M3095
Fleece Full Zip

M XS - XXL

Active

N/A

Component	Material	Description	Fabric Width	Supplier	Locked	Country of Origin	Managing Liaison Office	UoM	Target Cost	FOB Unit Cost	CIF Unit Cost	Usage	Wastage %	Total FOB	Total CIF
Label Logo 3	059197	USE ONLY FOR ALL ADULTSIZES AND YOUTH S-XL 42mm x 8mm Lightweight Stripe woven ECO Hanger Loop DOWN 2 clr other colors w Director approval only	0.0	Avery Dennison Global	N	China	Portland	ea	0.0	0.02823	0.0	1.000	5.0	0.030	0.000
Phero 1	105916	1.2mm ticked d/c with soft rubber textured phemo (Short) Call out Base color d/c, Tick color, Rubber	0.0	UTS-Universal Trim Supply Co.	N	Taiwan	Taiwan-Taipei	ea	0.0	0.154	0.0	4.000	2.0	0.628	0.000
Thread 1	008214	Coats ASTRA Spun Polyester Tex 27 40/2	0.0	Coats Global Thread	N	unassigned	Portland	meter	0.0	0.0003	0.0	620.000	5.0	0.195	0.000

Costing BOM

Line Slot: PFG Uncharted Fleece Full Zip

State: Production

Season: F24

Merchandise Division: Sportswear

Merchandise Collection: PFG

Product Class: Fleece FZ

Designer: mdavis

Developer: cdemmitt

LO Developer: kkokul

Sourcing Manager: melissa.gallagher

Fit Engineer: kicampbell



Design: F4MS209661

Sample LO: India

Production LO: India

Style Material Style

Style Description Pattern

Base Size Size Scale

Fit SMU Type

FO9344 2096611

PFG Uncharted™ M24M3095
Fleece Full Zip

M XS - XXL

Active

N/A

Component	Material	Description	Fabric Width	Supplier	Locked	Country of Origin	Managing Liaison Office	UoM	Target Cost	FOB Unit Cost	CIF Unit Cost	Usage	Wastage %	Total FOB	Total CIF
Thread 2	110529	Coats Astra spun Polyester Tex 30	0.0	Coats Global Thread	N	unassigned	Portland	meter	0.0	0.000631	0.0	58.000	5.0	0.038	0.000
Toggle 1	108106	2 hole barrel toggle with 2 functioning ends for 1.5/2.2 d/c	0.0	Shimada Shoji (H.K.) Limited	N	China	Portland	ea	0.0	0.155	0.0	1.000	2.0	0.158	0.000
Washer 1	002614	Plastic Washer (Polyurethane) (use on all Snap Stud and Post or Eyelets if needed) Clear	0.0	Unitex International Button Accessories Ltd	N	China	Portland	ea	0.0	0.00592	0.0	2.000	3.0	0.012	0.000
Webbing and Tape 1	004611	5/8 in Grosgrain Tape, Poly 1 clr	0.0	Paiho Global	N	Taiwan	Taiwan-Taipei	yd	0.0	0.122	0.0	0.890	7.0	0.116	0.000

Costing BOM

Line Slot: PFG Uncharted Fleece Full Zip

State: Production

Season: F24

Merchandise Division: Sportswear

Merchandise Collection: PFG

Product Class: Fleece FZ

Designer: mdavis

Developer: cdemmitt

LO Developer: kgokul

Sourcing Manager: melissa.gallagher

Fit Engineer: kicampbell



Design: F4MS209661

Sample LO: India

Production LO: India

Style Material Style

Style Description Pattern

Base Size Size Scale

Fit SMU Type

FO9344

2096611

PFG Uncharted™ M24M3095
Fleece Full Zip

M

XS - XXL

Active

N/A

Component	Material	Description	Fabric Width	Supplier	Locked	Country of Origin	Managing Liaison Office	UoM	Target Cost	FOB Unit Cost	CIF Unit Cost	Usage	Wastage %	Total FOB	Total CIF
Webbing and Tape 2	360183	3/4 in W Foldover (3/8 to show) Woven Stretch Binding 1 clr FOR CAN STYLES PRODUCED IN VN use 110808	0.0	Paiho Global	N	Taiwan	Taiwan-Taipei	yd	0.0	0.16	0.0	1.850	7.0	0.317	0.000
Webbing and Tape 3	360027	3/8 in Grosgrain Tape Poly 1 clr	0.0	Paiho Global	N	Taiwan	Taiwan-Taipei	yd	0.0	0.068	0.0	1.850	7.0	0.135	0.000
Zipper 1	126810	CFOL-36 DAV3 E P12 TO-IPOM REVERSE OpenEnd Left-in AutoLk Enml Sldr/PI RevCoil	0.0	Ideal Fastener Global	N	unassigned	Portland	ea	0.0	0.4643	0.0	1.000	0.0	0.564	0.000
Zipper 2	126123	CFC-36 DA E B-E Clsd AutoLk Enml Sldr/PI EnmlBtmStp	0.0	Ideal Fastener Global	N	unassigned	Portland	ea	0.0	0.0481	0.0	1.000	0.0	0.060	0.000

Costing BOM

Line Slot: PFG Uncharted Fleece Full Zip

State: Production

Season: F24

Merchandise Division: Sportswear

Merchandise Collection: PFG

Product Class: Fleece FZ

Designer: mdavis

Developer: cdemmitt

LO Developer: kgokul

Sourcing Manager: melissa.gallagher

Fit Engineer: kicampbell



Design: F4MS209661

Sample LO: India

Production LO: India

Style Material Style

Style Description Pattern

Base Size Size Scale

Fit SMU Type

FO9344 2096611

PFG Uncharted™ M24M3095
Fleece Full Zip

M XS - XXL

Active

N/A

Component	Material	Description	Fabric Width	Supplier	Locked	Country of Origin	Managing Liaison Office	UoM	Target Cost	FOB Unit Cost	CIF Unit Cost	Usage	Wastage %	Total FOB	Total CIF
Zipper 3	126123	CFC-36 DA E B-E Clsd AutoLk Enml Sldr/PI EnmlBtmStp	0.0	Ideal Fastener Global	N	unassigned	Portland	ea	0.0	0.0481	0.0	2.000	0.0	0.124	0.000
Label 1	059199	40mm CSC Main /International ECO Size Woven Loop Label 3 clr	0.0	Avery Dennison Global	N	China	Portland	ea	0.0	0.05219	0.0	1.000	3.0	0.054	0.000
Label 2	006564	33mm Care Content ECO Booklet Fold label with fully translated country of origin WHT/BLK for most, BLK/WHT for Titanium only, GRY/BLK is for Garment DYE ONLY	0.0	Avery Dennison Global	N	China	Portland	ea	0.0	0.01905	0.0	1.000	3.0	0.020	0.000

Costing BOM

Line Slot: PFG Uncharted Fleece Full Zip

State: Production

Season: F24

Merchandise Division: Sportswear

Merchandise Collection: PFG

Product Class: Fleece FZ

Designer: mdavis

Developer: cdemmitt

LO Developer: kkokul

Sourcing Manager: melissa.gallagher

Fit Engineer: kicampbell



Design: F4MS209661

Sample LO: India

Production LO: India

Style Material Style

Style Description Pattern

Base Size Size Scale

Fit SMU Type

FO9344

2096611

PFG Uncharted™ M24M3095
Fleece Full Zip

M

XS - XXL

Active

N/A

Component	Material	Description	Fabric Width	Supplier	Locked	Country of Origin	Managing Liaison Office	UoM	Target Cost	FOB Unit Cost	CIF Unit Cost	Usage	Wastage %	Total FOB	Total CIF
Hangtag Package Part	097308	PFG No Tech Hangtag	0.0	Hang Sang Press Co. Ltd	N	unassigned	Portland	ea	0.0	0.0167	0.0	1.000	0.0	0.017	0.000
Hangtag Package Part	121612	MSRP/UPC with RFID Specs for MSRP. Please refer to VAS specs for any exceptions. MSRP required on all product shipping to the US.	0.0	Avery Dennison Global	N	unassigned	Portland	ea	0.0	0.04875	0.0	1.000	0.0	0.049	0.000
Hangtag Package Part	126966	Active Fit Swing Tag	0.0	Hang Sang Press Co. Ltd	N	unassigned	Portland	ea	0.0	0.023	0.0	1.000	0.0	0.023	0.000

Costing BOM

Line Slot: PFG Uncharted Fleece Full Zip

State: Production

Season: F24

Merchandise Division: Sportswear

Merchandise Collection: PFG

Product Class: Fleece FZ

Designer: mdavis

Developer: cdemmitt

LO Developer: kgokul

Sourcing Manager: melissa.gallagher

Fit Engineer: kicampbell



Design: F4MS209661

Sample LO: India

Production LO: India

Style Material Style

Style Description Pattern

Base Size Size Scale

Fit SMU Type

FO9344 2096611

PFG Uncharted™ M24M3095
Fleece Full Zip

M XS - XXL

Active

N/A

Component	Material	Description	Fabric Width	Supplier	Locked	Country of Origin	Managing Liaison Office	UoM	Target Cost	FOB Unit Cost	CIF Unit Cost	Usage	Wastage %	Total FOB	Total CIF
Packaging 1	980001	Polybag See Standard CCS 4200 for specifications	0.0	Contractor	N	unassigned	Hong Kong	ea	0.0	0.0	0.0	1.000	3.0	0.000	0.000
Packaging 2	980010	UPC Bag Sticker Generic (MHW/Columbia) See CCS4400/4401 and MHW4402 for Mt Hardware for instructions	0.0	Bao Shen (Apparel)	N	unassigned	Portland	ea	0.0	0.011	0.0	1.000	5.0	0.012	0.000

Costing BOM

Line Slot: PFG Uncharted Fleece Full Zip		State: Production		Season: F24			
Merchandise Division: Sportswear		Merchandise Collection: PFG		Product Class: Fleece FZ			
Designer: mdavis		Developer: cdemmitt		LO Developer: kgokul			
Fit Engineer: kicampbell				Sourcing Manager: melissa.gallagher			
Design:	F4MS209661	Sample LO:	India	Production LO:	India		
Style	Material Style	Style Description	Pattern	Base Size	Size Scale	Fit	SMU Type
FO9344	2096611	PFG Uncharted™ Fleece Full Zip	M24M3095	M	XS - XXL	Active	N/A



This is confidential and proprietary information of Columbia Sportswear Company. You agree that you will not disclose this information to any third party or use it for any purpose other than on behalf of Columbia. You have no right to use Columbia's name or any of its trademarks, trade names, copyrights, patents, designs or other intellectual property except as set forth in writing by Columbia.

Instructions



Line Slot: PFG Uncharted Fleece Full Zip State: Production Season: F24
 Merchandise Division: Sportswear Merchandise Collection: PFG Product Class: Fleece FZ
 Designer: mdavis Developer: cdemmitt LO Developer: kgokul Sourcing Manager: melissa.gallagher
 Fit Engineer: kicampbell
 Design: F4MS209661 Sample LO: India Production LO: India
 Style: FO9344 Material Style: 2096611 Style Description: PFG Uncharted™ Fleece Full Zip Pattern: M24M3095 Base Size: M Size Scale: XS - XXL Fit: Active SMU Type: N/A

Category	Subcategory	Description	Comments
BARTACKS	BARTACK FUNCTIONAL	SEE COMMENTS	See sketch for bartack placement

This is confidential and proprietary information of Columbia Sportswear Company. You agree that you will not disclose this information to any third party or use it for any purpose other than on behalf of Columbia. You have no right to use Columbia's name or any of its trademarks, trade names, copyrights, patents, designs or other intellectual property except as set forth in writing by Columbia.

Care Report

Line Slot: PFG Uncharted Fleece Full Zip	State: Production	Season: F24
Merchandise Division: Sportswear	Merchandise Collection: PFG	Product Class: Fleece FZ
Designer: mdavis	Developer: cdemmitt	LO Developer: kgokul
Fit Engineer: kicampbell		Sourcing Manager: melissa.gallagher
Design: F4MS209661	Sample LO: India	Production LO: India
Style: Material Style	Style Description	Pattern
FO9344	2096611	PFG Uncharted™ Fleece Full Zip
	M24M3095	M
		XS - XXL
		Active
		SMU Type
		N/A



Care Code: 1031		Color Way Number	Color Way Name
English	Machine Wash Cold Gentle, Wash Separately, Do Not Bleach, Tumble Dry Low, Remove Promptly, Iron Low No Steam, Do Not Use Fabric Softener, If Present Do Not Iron Decal, Do Not Dryclean	011	Shark, Shark
French	Lavage machine à froid, Cycle délicat, Laver séparément, Ne pas utiliser d'eau de javel, Séchage machine, basse température, Sortir immédiatement de la machine, Repasser à basse température, sans vapeur, Ne pas utiliser d'assouplissant, Le cas échéant, ne pas repasser la décalcomanie, Nettoyage à sec interdit	012	Shark, Dark Stone
German	Schonwaschgang mit kaltem Wasser, Separat waschen, Keine Bleichmittel verwenden, Trocknen im Wäschetrockner bei niedriger Temperatur, Sofort aus dem Trockner nehmen, Bügeln mit niedriger Temperatur ohne Dampf, Keine Weichspüler verwenden, Falls vorhanden, Dekorbild nicht bügeln, Nicht chemisch reinigen	254	Iron, Iron
Portuguese	Lavar à maquina com água fria, ciclo para roupas delicadas, Lavar separadamente, Não alvejar, Secar à máquina em temperatura baixa, Remover prontamente, Passar a ferro em baixa temperatura, sem vapor, Não usar amaciante, Se presente, não passar o ferro sobre o decalque, Não utilizar limpeza a seco	316	Cypress, Cypress
Spanish	Lavar a maquina con agua fría, en ciclo delicado, Lavar por separado, No usar lejía, Usar secadora a temperatura baja, Retirar inmediatamente, Planchar a temperatura baja sin vapor, No usar suavizante de telas, En su caso, no planche la pegatina, No lavar en seco		
Italian	Lavare in lavatrice in acqua fredda, ciclo delicato, Lavare separatamente, Non candeggiare, Asciugare a tamburo a bassa temperatura, Rimuovere tempestivamente, Stirare con ferro a temperatura bassa senza vapore, Non utilizzare ammorbidente, Se presente, non stirare la decalcomania, Non lavare a secco		
Russian	Щадящая машинная стирка в холодной воде, Стирать отдельно, Не отбеливать, Сушить при низкой температуре, Сразу убрать из сушилки, Гладить при низкой температуре без пара, Не использовать кондиционер для тканей, Если есть, не гладить наклейки и роспись на текстиле, Химчистка запрещена		
Czech Republic	Praní v pračce při nízké teplotě, jemný cyklus, Prát samostatně, Nebělit, Sušení v sušičce, nízká teplota, Ihned odepnout, Žehlení při nízké teplotě bez páry, Nepoužívat aviváž, Nežehlit obtisky, jsou-li přítomny, Nečistit chemicky		
Hebrew	כביסה במכונה במים קרים, כביסה עדינה, לכבס בנפרד, לא להלבין, לייבש במייבש כביסה בחום נמוך, להסיר מיד, לגהץ בחום נמוך ללא אדים, לא להשתמש במרכך כביסה, אם ישנה, לא לגהץ את מדבקת הדקאל, לא לנקות בניקוי יבש		
Hungarian	Géppel mossa, hideg vízzel, kímélő programmal, Különválasztva mossa, Ne hasznájon fehérítőt, Szárítógépben alacsony hőfokon szárítsa, Mosás után azonnal vegye ki a gépből, Alacsony hőfokon vasalja, gőzölés nélkül, Ne használjon öblítőszer, Ha van az anyagon matrica, azt ne vasalja, Ne vegytisztítsa		
Polish	Prać w temperaturze nie przekraczającej 30°C, cykl delikatny, Prac oddzielnie, Nie chlorować, Można suszyć bębnowo, niska temperatura, Natychmiast usunąć, Prasować w temperaturze do 100°C bez pary, Nie używać zmiękczacza do tkanin, Nie prasować ozdób, jeśli są obecne, Nie czyścić chemicznie		
Portuguese Brazil	Lavar à maquina com água fria, ciclo para roupas delicadas, Lavar separadamente, Não alvejar, Secar em tambor rotativo em temperatura baixa, Remover prontamente, Passar a ferro em baixa temperatura, sem vapor, Não usar amaciante, Se presente, não passar o ferro sobre o decalque, Não utilizar limpeza a seco		
Slovakian	Perte v pračke v studenej vode, šetriaci program, Perte oddelene, Neodfarbujte, Sušte v bubnovej sušičke pri nízkych otáčkach, Okamžite odstráňte, Žehlite žehličkou s nízkou teplotou bez pary, Nepoužívajte avivážne prípravky, Ak má štítok, nežehlite ho, Nečistite chemicky		
Slovenian	Nežno mrzlo strojno pranje, Prati posebej, Ne belite, Nizko strojno sušenje, Odstraniti takoj, Nizko likanje brez pare, Ne uporabljati mehčalca, Če obstaja, ne likati nalepk, Ne suho čistiti		
Spanish Latin American	Lavar a maquina con agua fría, en ciclo delicado, Lavar por separado, No usar blanqueador, Usar secadora a temperatura baja, Retirar inmediatamente, Planchar a temperatura baja sin vapor, No usar suavizante de telas, En su caso, no planche el diseño impreso, No lavar en seco		
Turkish	Makinada Yıkandır, Soğuk, Narin Program, Ayrı Yıkayın, Ağartıcı Kullanmayın, Tambur Kurutma, Düşük, Hemen Çıkarın, Düşük Isıda Ütüleyin, Buharsız, Çamaşır Yumuşatıcısı Kullanmayın, Varsa Çıkartmayı Ütülemeyin, Kuru Temizleme Yapmayın		

Content Report

Line Slot: PFG Uncharted Fleece Full Zip		State: Production		Season: F24			
Merchandise Division: Sportswear	Merchandise Collection: PFG	Product Class: Fleece FZ					
Designer: mdavis	Developer: cdemmitt	LO Developer: kgokul		Sourcing Manager: melissa.gallagher			
Fit Engineer: kicampbell							
Design:	F4MS209661	Sample LO:	India	Production LO:	India		
Style	Material Style	Style Description	Pattern	Base Size	Size Scale	Fit	SMU Type
FO9344	2096611	PFG Uncharted™ Fleece Full Zip	M24M3095	M	XS - XXL	Active	N/A



CONTENT CODE: RXA		Color Way Number	Color Way Name
Shell: 100% Recycled Polyester			
Overlay: 100% Tactel Nylon Exclusive of Trimming			
FRENCH	Extérieur: 100% Polyester recyclé Revêtement: 100% Tactel Polyamide Sauf les bordures	316	Cypress, Cypress
GERMAN	Außenhülle: 100% Recycled Polyester Überzug: 100% Nylon Tactel Ohne Besatz	254	Iron, Iron
PORTUGUESE	Exterior: 100% Poliéster reciclado Revestimento: 100% Nylon Tactel Sem orlas	012	Shark, Dark Stone
SPANISH	Cubierta: 100% Poliéster reciclado Recubrimiento: 100% Nilón Tactel Exclusivo de los ribetes	011	Shark, Shark
ITALIAN	Guscio esterno: 100% Poliestere riciclato Applicazione: 100% Tattile in Nylon Ad eccezione dei bordini		
RUSSIAN	Оболочка: 100% Утилизированный полиэфир Покрывало: 100% Нейлон Тактель Без дополнительных деталей		
CZECH REPUBLICAN	Skořepina: 100% Recyklovaný polyester Vrchní vrstva: 100% Tactel Nylon Bez nášivek		
HEBREW	מעטפת חיצונית: ציפוי:	100% פוליאסטר ממוחזר 100% ניילון טקטל ללא קישוט	
HUNGARIAN	Külső: 100% Újrahasznosított poliészter Rátét: 100% Tactel nejlon Szegélydíszen kívül		
POLISH	Powłoka: 100% Poliester z recyklingu Powłoka: 100% Nylon Tactel Wyłączając naszywki		
PORTUGUESE BRAZIL	Exterior: 100% Poliéster reciclado Revestimento: 100% Náilon Tactel Sem adornos		
SLOVAKIAN	Plášť: 100% Recyklovaný polyester Pokryvka: 100% Nylon Tactel Okrem lemovania		
SLOVENIAN	Lupina: 100% Reciklirani poliester Prekrivno: 100% Tactel najlon Brez obrezovanja		
SPANISH LATIN AMERICAN	Cubierta: 100% Poliéster reciclado Recubrimiento: 100% Nailon Tactel Exclusivo de los ribetes		
TURKISH	Kabuk: 100% Geri Dönüşümlü Polyester Kaplama: 100% Taktel Naylon Süsler Hariç		

Content Report

Line Slot: PFG Uncharted Fleece Full Zip		State: Production		Season: F24			
Merchandise Division: Sportswear		Merchandise Collection: PFG		Product Class: Fleece FZ			
Designer: mdavis		Developer: cdemmitt		LO Developer: kgokul			
Fit Engineer: kicampbell		Sourcing Manager: melissa.gallagher					
Design:	F4MS209661	Sample LO:	India	Production LO:	India		
Style	Material Style	Style Description	Pattern	Base Size	Size Scale	Fit	SMU Type
FO9344	2096611	PFG Uncharted™ Fleece Full Zip	M24M3095	M	XS - XXL	Active	N/A



CHINESE SIMPLIFIED	外壳:	100% 可回收聚酯纤维
	叠加:	100% TACTEL尼龙 不包括装饰品
CHINESE TRADITIONAL	外殼:	100% 可回收聚酯纖維
	疊加:	100% TACTEL尼龍 不包括裝飾品
JAPANESE	シェル:	100% リサイクルポリエステル
	上張り:	100% TACTELナイロン 装飾品を除く
KOREAN	:	100%
	:	100% TACTEL
DANISH	Skal:	100% Genbrugt polyester
	Overbetræk:	100% Tactel nylon Inkluderer ikke kant
NORWEGIAN	Skall:	100% Resirkulert polyester
	Overtrekk:	100% Tactel nylon Eksklusiv trimming
SWEDISH	Ytterdel:	100% Återvunnen polyester
	Överlägg:	100% Tactel nylon Utan trimming
DUTCH	Schelp:	100% Gerecyclede polyester
	Overtrek:	100% Tactel-nylon Exclusief trimmen
FRENCH CANADIAN	Extérieur:	100% Polyester recyclé
	Superposition:	100% Nylon Tactel Exclut les bordures

Pattern Piece Detail



Line Slot: PFG Uncharted Fleece Full Zip		State: Production		Season: F24			
Merchandise Division: Sportswear	Merchandise Collection: PFG	Product Class: Fleece FZ					
Designer: mdavis	Developer: cdemmitt	LO Developer: kgokul		Sourcing Manager: melissa.gallagher			
Fit Engineer: kicampbell							
Design:	F4MS209661	Sample LO:	India	Production LO:	India		
Style	Material Style	Style Description	Pattern	Base Size	Size Scale	Fit	SMU Type
FO9344	2096611	PFG Uncharted™ Fleece Full Zip	M24M3095	M	XS - XXL	Active	N/A

M24M3095 -

Component	Quantity	Long Description	Abbreviation	Code
-----------	----------	------------------	--------------	------

This is confidential and proprietary information of Columbia Sportswear Company. You agree that you will not disclose this information to any third party or use it for any purpose other than on behalf of Columbia. You have no right to use Columbia's name or any of its trademarks, trade names, copyrights, patents, designs or other intellectual property except as set forth in writing by Columbia.

Measurements

Line Slot: PFG Uncharted Fleece Full Zip

State: Production

Season: F24

Merchandise Division: Sportswear

Merchandise Collection: PFG

Product Class: Fleece FZ

Designer: mdavis

Developer: cdemmitt

LO Developer: kgokul

Sourcing Manager: melissa.gallagher

Fit Engineer: kicampbell



Design: F4MS209661

Sample LO: India

Production LO: India

Style Material Style

Style Description Pattern

Base Size Size Scale

Fit SMU Type

FO9344

2096611

PFG Uncharted™
Fleece Full Zip

M

XS - XXL

Active

N/A

Sort Order		Use	Type	Placemen t	(+/-)	XS	S	M	L	XL	XXL
Grade Rule: CSC Mens Knit Tops - XXS-XXL (M) - Block: null											
1101.0	CHEST WIDTH - circumference - 1 inch down from armhole seam	QC	Graded		0.75	38.0	41.0	44.0	47.0	51.0	55.0
1300.0	WAIST WIDTH POSITION - from HPS		Graded		0.0	17.75	18.125	18.5	18.875	19.25	19.625
1400.0	WAIST WIDTH - circumference	QC	Graded		0.75	36.0	39.0	42.0	45.0	49.0	53.0
1610.0	SWEEP WIDTH - circumference	QC	Graded		0.75	36.0	39.0	42.0	45.0	49.0	53.0
2002.0	BACK BODY LENGTH - CB neck to edge of hem	QC	Graded		0.5	28.0	28.5	29.0	29.5	30.0	30.5
2203.0	SHOULDER WIDTH - Natural Shoulder - seam to seam	QC	Graded		0.375	16.5	17.5	18.5	19.5	20.75	22.0
2602.0	SLEEVE LENGTH - Long Sleeve - CB neck to hem edge	QC	Graded		0.5	34.5	35.25	36.0	36.75	37.625	38.5
2722.0	SLEEVE WIDTH - circumference - 1 inch down from armhole seam	QC	Graded		0.375	17.25	18.0	18.75	19.5	20.5	21.5
2822.0	ELBOW WIDTH - circumference - at mid point of under sleeve seam	QC	Graded		0.25	13.25	13.75	14.25	14.75	15.375	16.0
3002.0	SLEEVE OPENING - long sleeve (Relaxed) - circumference	QC	Graded		0.25	8.25	8.5	8.75	9.0	9.25	9.5
3004.0	SLEEVE OPENING - long sleeve (Extended) - circumference	QC	Graded		0.25	10.0	10.25	10.5	10.75	11.0	11.25
3450.0	NECK CIRCUMFERENCE - at seam	QC	Graded		0.25	18.5	19.5	20.5	21.5	22.5	23.5
3600.0	COLLAR LENGTH - at top	QC	Graded		0.25	18.0	19.0	20.0	21.0	22.0	23.0
3650.0	COLLAR HEIGHT - at CB	QC	Graded		0.125	2.5	2.5	2.5	2.5	2.5	2.5
3651.0	COLLAR HEIGHT - at CF	QC	Graded		0.125	2.5	2.5	2.5	2.5	2.5	2.5

Measurements

Line Slot: PFG Uncharted Fleece Full Zip

State: Production

Season: F24

Merchandise Division: Sportswear

Merchandise Collection: PFG

Product Class: Fleece FZ

Designer: mdavis

Developer: cdemmitt

LO Developer: kgokul

Sourcing Manager: melissa.gallagher

Fit Engineer: kicampbell



Design: F4MS209661

Sample LO: India

Production LO: India

Style Material Style

Style Description Pattern

Base Size Size Scale

Fit SMU Type

FO9344 2096611

PFG Uncharted™
Fleece Full Zip M24M3095

M XS - XXL

Active

N/A

Sort Order		Use	Type	Placemen t	(+/-)	XS	S	M	L	XL	XXL
6501.0	CHEST POCKET WIDTH		Varies By Style		0.125	5.0	5.5	5.5	5.5	6.0	6.0
6502.0	CHEST POCKET HEIGHT		Varies By Style		0.25	6.5	7.0	7.0	7.0	7.5	7.5
6620.0	LOWER FRONT POCKET OPENING		Varies By Style		0.25	7.5	8.0	8.0	8.0	8.5	8.5
6622.0	LOWER FRONT POCKET HEIGHT		Varies By Style		0.25	9.5	10.0	10.0	10.0	10.5	10.5
6625.0	LOWER FRONT POCKET WIDTH - at top		Varies By Style		0.25	6.5	7.0	7.0	7.0	7.5	7.5
6626.0	LOWER FRONT POCKET WIDTH - at bottom		Varies By Style		0.25	6.875	7.375	7.375	7.375	7.875	7.875
930.0	Drawcord-Cording-Laces 1		Component		0.0	45.0	48.0	51.0	54.0	58.0	62.0
1070.0	Elastic 1		Component		0.0	9.25	9.5	9.75	10.0	10.25	10.5
3190.0	Webbing and Tape 1		Component		0.0	2.5	2.5	2.5	2.5	2.5	2.5
3210.0	Webbing and Tape 2		Component		0.0	58.0	59.0	60.0	61.0	62.0	63.0
3670.0	Zipper 1		Component		0.0	26.75	27.75	28.75	29.75	30.75	31.75
3690.0	Zipper 2		Component		0.0	6.0	6.5	6.5	6.5	7.0	7.0
3710.0	Zipper 3		Component		0.0	6.5	7.0	7.0	7.0	7.5	7.5

Measurements

Line Slot: PFG Uncharted Fleece Full Zip		State: Production		Season: F24			
Merchandise Division: Sportswear	Merchandise Collection: PFG	Product Class: Fleece FZ					
Designer: mdavis	Developer: cdemmitt	LO Developer: kgokul		Sourcing Manager: melissa.gallagher			
Fit Engineer: kicampbell							
Design:	F4MS209661	Sample LO:	India	Production LO:	India		
Style	Material Style	Style Description	Pattern	Base Size	Size Scale	Fit	SMU Type
FO9344	2096611	PFG Uncharted™ Fleece Full Zip	M24M3095	M	XS - XXL	Active	N/A



This is confidential and proprietary information of Columbia Sportswear Company. You agree that you will not disclose this information to any third party or use it for any purpose other than on behalf of Columbia. You have no right to use Columbia's name or any of its trademarks, trade names, copyrights, patents, designs or other intellectual property except as set forth in writing by Columbia.

Sales Sample Comments - FO9344

Line Slot: PFG Uncharted Fleece Full Zip State: Production Season: F24
 Designer: mdavis Developer: cdemmitt LO Developer: kgokul Sourcing Manager: melissa.gallagher

Style	Material Style	Style Description	Design	Pattern	Base Size	Size Scale	Sample LO	Production LO
FO9344	2096611	PFG Uncharted™ Fleece Full Zip	F4MS209661	M24M3095	M	XS - XXL	India	India



Report #: 0000061247 Office: India Factory Code: SEP Factory Name: SHAHI EXPORTS PVT. LTD.
 Sample Sizes: M Estimated First Buy Date: Factory Country of Origin: India
 Comments: CC 011, 012, 254, 316

MEASUREMENT CHART - SIZE M

Point of Measure	Use	Type	(+/-)	Requested	LO Actual	Difference	QA Actual	Difference
CHEST WIDTH - circumference - 1 inch down from armhole seam	QC	Graded	0.75	44.0				
WAIST WIDTH - circumference	QC	Graded	0.75	42.0				
SWEEP WIDTH - circumference	QC	Graded	0.75	42.0				
BACK BODY LENGTH - CB neck to edge of hem	QC	Graded	0.5	29.0				
SHOULDER WIDTH - Natural Shoulder - seam to seam	QC	Graded	0.375	18.5				
SLEEVE LENGTH - Long Sleeve - CB neck to hem edge	QC	Graded	0.5	36.0				
SLEEVE WIDTH - circumference - 1 inch down from armhole seam	QC	Graded	0.375	18.75				
ELBOW WIDTH - circumference - at mid point of under sleeve seam	QC	Graded	0.25	14.25				
SLEEVE OPENING - long sleeve (Relaxed) - circumference	QC	Graded	0.25	8.75				
SLEEVE OPENING - long sleeve (Extended) - circumference	QC	Graded	0.25	10.5				
NECK CIRCUMFERENCE - at seam	QC	Graded	0.25	20.5				
COLLAR LENGTH - at top	QC	Graded	0.25	20.0				
COLLAR HEIGHT - at CB	QC	Graded	0.125	2.5				
COLLAR HEIGHT - at CF	QC	Graded	0.125	2.5				

Liaison Office Comments ravi 9/21/2023 11:47:45 PM

Fabric

No Comments.

Trims

No Comments.

Sales Sample Comments - FO9344

Line Slot: PFG Uncharted Fleece Full Zip

State: Production

Season: F24

Designer: mdavis

Developer: cdemmitt

LO Developer: kgokul

Sourcing Manager: melissa.gallagher



Style	Material Style	Style Description	Design	Pattern	Base Size	Size Scale	Sample LO	Production LO
FO9344	2096611	PFG Uncharted™ Fleece Full Zip	F4MS209661	M24M3095	M	XS - XXL	India	India

Report #: 0000061247

Office: India

Factory Code: SEP

Factory Name: SHAHI EXPORTS PVT. LTD.

Sample Sizes: M

Estimated First Buy Date:

Factory Country of Origin: India

Comments: CC 011, 012, 254, 316

Embellishment

N/A

Garment dye/Wash

Non Wash

Measurement

With in tolerance.

Construction

Center front zipper wavy.

Roping at Shell 2 seams.

Chest pocket shape off.

Product Developer Comments

This is confidential and proprietary information of Columbia Sportswear Company. You agree that you will not disclose this information to any third party or use it for any purpose other than on behalf of Columbia. You have no right to use Columbia's name or any of its trademarks, trade names, copyrights, patents, designs or other intellectual property except as set forth in writing by Columbia.

Sales Sample Comments - FO9344

Line Slot: PFG Uncharted Fleece Full Zip

State: Production

Season: F24

Designer: mdavis

Developer: cdemmitt

LO Developer: kgokul

Sourcing Manager: melissa.gallagher

Style	Material Style	Style Description	Design	Pattern	Base Size	Size Scale	Sample LO	Production LO
FO9344	2096611	PFG Uncharted™ Fleece Full Zip	F4MS209661	M24M3095	M	XS - XXL	India	India



Report #: 0000061247

Office: India Factory Code: SEP

Factory Name: SHAHI EXPORTS PVT. LTD.

Sample Sizes: M

Estimated First Buy Date:

Factory Country of Origin: India

Comments: CC 011, 012, 254, 316

Thumbnail

Line Slot: PFG Uncharted Fleece Full Zip

State: Production

Season: F24

Merchandise Division: Sportswear

Merchandise Collection: PFG

Product Class: Fleece FZ

Designer: mdavis

Developer: cdemmitt

LO Developer: kgokul

Sourcing Manager: melissa.gallagher

Fit Engineer: kicampbell



Design: F4MS209661

Sample LO: India

Production LO: India

Style Material Style

Style Description Pattern

Base Size Size Scale

Fit SMU Type

FO9344 2096611

PFG Uncharted™ M24M3095
Fleece Full Zip

M XS - XXL

Active N/A

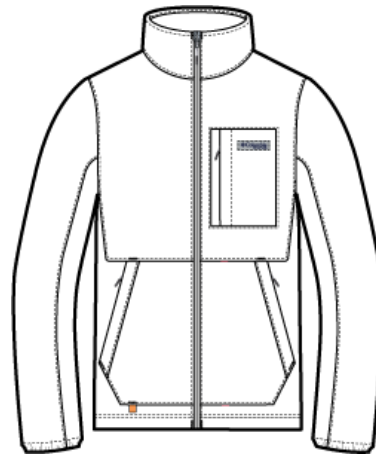

This is confidential and proprietary information of Columbia Sportswear Company. You agree that you will not disclose this information to any third party or use it for any purpose other than on behalf of Columbia. You have no right to use Columbia's name or any of its trademarks, trade names, copyrights, patents, designs or other intellectual property except as set forth in writing by Columbia.

Technical

Line Slot: PFG Uncharted Fleece Full Zip	State: Production	Season: F24
Merchandise Division: Sportswear	Merchandise Collection: PFG	Product Class: Fleece FZ
Designer: mdavis	Developer: cdemmitt	LO Developer: kgokul
Fit Engineer: kicampbell	Sourcing Manager: melissa.gallagher	
Design: F4MS209661	Sample LO: India	Production LO: India
Style: FO9344	Material Style: 2096611	Style Description: PFG Uncharted™ Fleece Full Zip
Pattern: M24M3095	Base Size: M	Size Scale: XS - XXL
Fit: Active	SMU Type: N/A	



Last Updated: 10.30.23 CD

*All Shell ① unless Indicated

ISO 301 Single Needle, 1/8" from edge, unless otherwise noted

INTERFACING 1: Inside Collar, Chest Pocket Welt
 THREAD 1: Bobbin & Overlock
 THREAD 2: Topstitch

ALL SHELL 2 IS OVERLAY on top of Shell 1

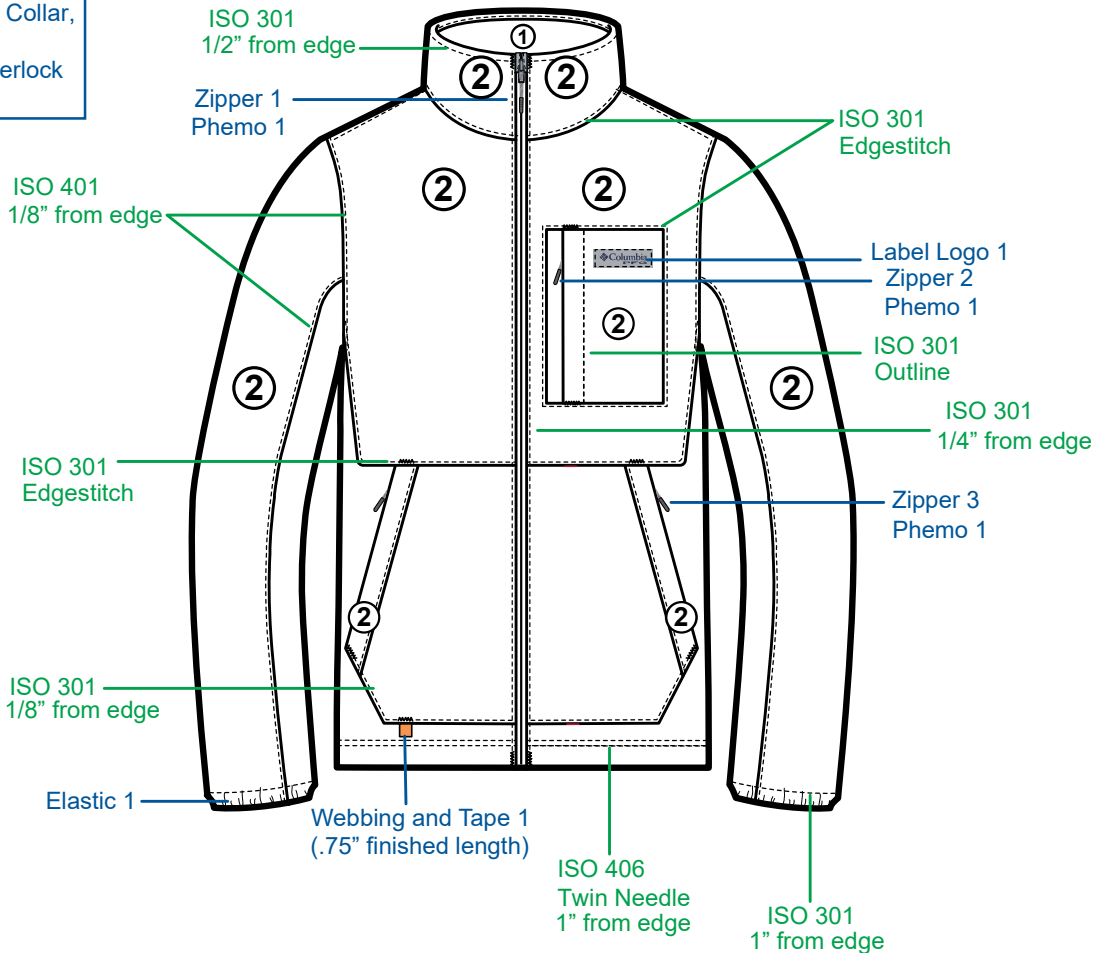

Technical

Line Slot: PFG Uncharted Fleece Full Zip		State: Production	Season: F24
Merchandise Division: Sportswear	Merchandise Collection: PFG	Product Class: Fleece FZ	
Designer: mdavis	Developer: cdemmitt	LO Developer: kgokul	Sourcing Manager: melissa.gallagher
Fit Engineer: kicampbell			

Design:	F4MS209661	Sample LO:	India	Production LO:	India		
Style	Material Style	Style Description	Pattern	Base Size	Size Scale	Fit	SMU Type
FO9344	2096611	PFG Uncharted™ Fleece Full Zip	M24M3095	M	XS - XXL	Active	N/A

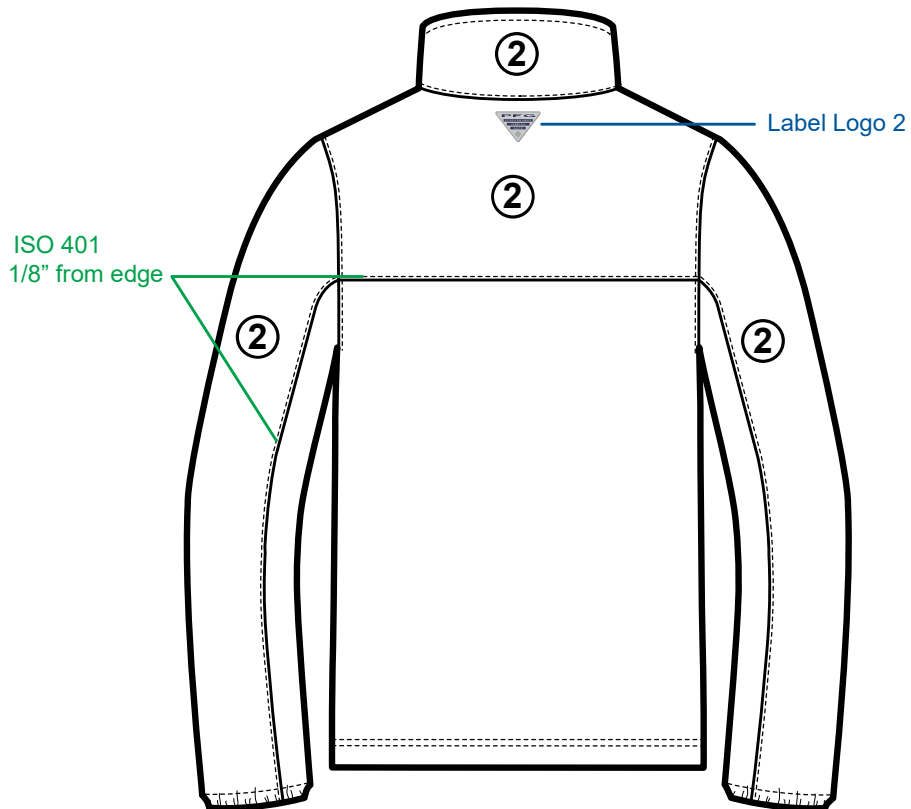

Technical

Line Slot: PFG Uncharted Fleece Full Zip		State: Production		Season: F24			
Merchandise Division: Sportswear		Merchandise Collection: PFG		Product Class: Fleece FZ			
Designer: mdavis		Developer: cdemmitt		LO Developer: kgokul			
Fit Engineer: kicampbell				Sourcing Manager: melissa.gallagher			
Design:	F4MS209661	Sample LO:	India	Production LO:	India		
Style	Material Style	Style Description	Pattern	Base Size	Size Scale	Fit	SMU Type
FO9344	2096611	PFG Uncharted™ Fleece Full Zip	M24M3095	M	XS - XXL	Active	N/A



Last Updated: 06.05.23 LC

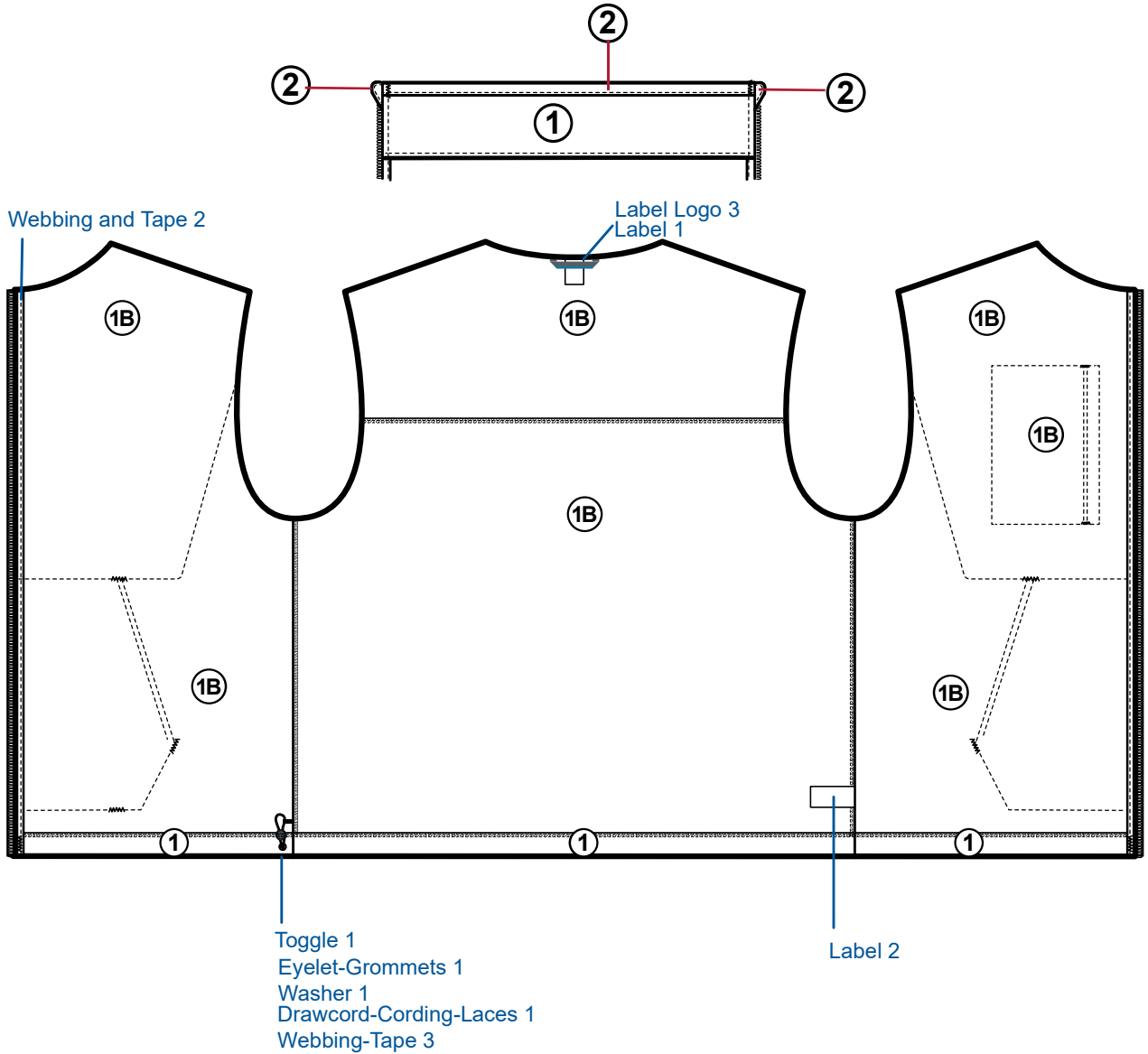

Technical

Line Slot: PFG Uncharted Fleece Full Zip		State: Production	Season: F24
Merchandise Division: Sportswear	Merchandise Collection: PFG	Product Class: Fleece FZ	
Designer: mdavis	Developer: cdemmitt	LO Developer: kgokul	Sourcing Manager: melissa.gallagher
Fit Engineer: kicampbell			

Design:	F4MS209661	Sample LO:	India	Production LO:	India		
Style	Material Style	Style Description	Pattern	Base Size	Size Scale	Fit	SMU Type
FO9344	2096611	PFG Uncharted™ Fleece Full Zip	M24M3095	M	XS - XXL	Active	N/A



Set behind pocket construction:
 Back layer is all Shell 1
 Front layer is all shell 2
 (No Chamois Touch lining)

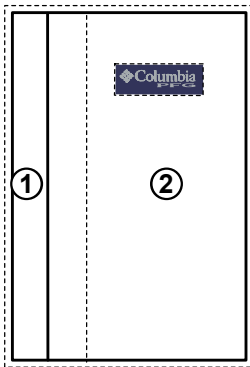

Double chin guard detail:

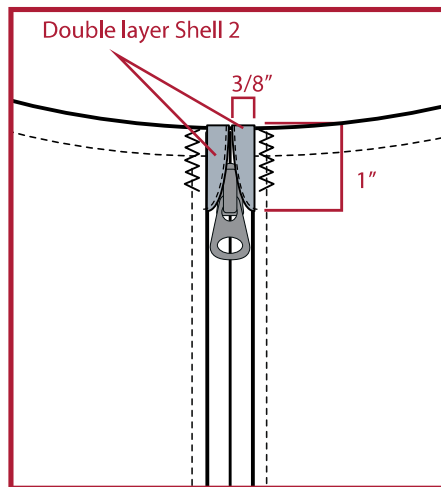

This is confidential and proprietary information of Columbia Sportswear Company. You agree that you will not disclose this information to any third party or use it for any purpose other than on behalf of Columbia. You have no right to use Columbia's name or any of its trademarks, trade names, copyrights, patents, designs or other intellectual property except as set forth in writing by Columbia.

Hangtag Package Report

Apparel Style: FO9344

Season: F24

Brand: Columbia

Merchandise Category: Sportswear

Merchandiser: fboulot

Line Slot: PFG Uncharted Fleece Full Zip

Sort Order: 0.5 Part: 126966 - Active Fit Swing Tag
 Instruction: Swing tag to be placed on top of cover tag on same plastic loop.

SKU Reference #1	Label	Name	Expiry Date
OP1490983	126966	OP1490983_126966_MT_Active Fit	10-18-23



SKU Code	Label	Material	Material #1
Process Blue / Process Blue	32pt C25		MT-1
275 x 137 / 1056mm x 538mm	Agapour Coating Die Cut, 3mm punch		

Sort Order: 1.0 Part: 097308 - PFG No Tech Hangtag
 Instruction: (ALL TOPS WITH A FRONT ZIPPER OR WITH DEPT STORE C/F) Hangtags are to be placed on one 5" circular swift tack looped through center front zipper

SKU Reference #1	Label	Name	Expiry Date
OP984556	097308	OP984556_097308_TC_PFG_No Tech	09-26-22

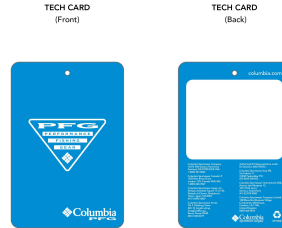

SKU Code	Label	Material	Material #1
Process Blue / Process Blue	32pt C25		TC-1
231 x 148 / 583mm x 365mm	Agapour Coating Die Cut, 3mm Punch		

Sort Order: 9.0 Part: 121612 - MSRP/UPC with RFID Specs for MSRP.
 Please refer to VAS specs for any exceptions. MSRP required on all product shipping to the US.
 Instruction:

SKU Reference #1	Label	Name	Expiry Date
n/a	121612	PDM_121612_RFID UPC Sticker...Dec...3...2022	12-03-22



SKU Code	Label	Material	Material #1
Black	White, Dual Matrix Sticker Stock		UPC-5
15855 x 16267 / 505mm x 413mm	Direct, Inkjet in Performance 3mm up from bottom 1/8"		