

<b>Tech Pack</b>	Production with new Care Format
<b>Description</b>	Production F24 and newer

### Message

RSL: It is expected that all goods produced for Carhartt comply fully with the Restricted Substances List (RSL) published by the Apparel and Footwear International RSL Management Group. The AFIRM RSL is available at the link below. If you should have any concerns in meeting this product specification, please discuss with the Carhartt Development Team, Fabric and Testing Manager, Quality Manager, or Sourcing Manager. <https://www.afirm-group.com/afirm-rsl/>

### Properties

**Front\_Sketch**                      **Back\_Sketch**

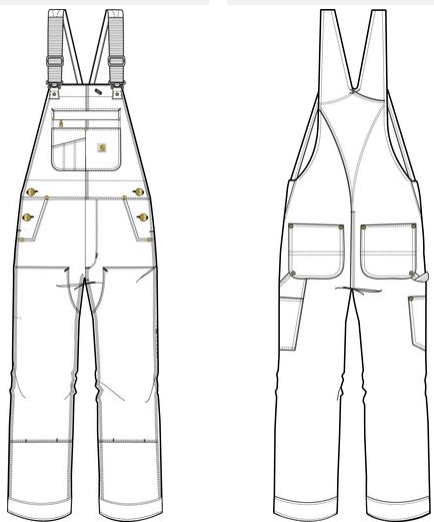

<b>Style #</b>	102776
<b>Style Description</b>	R01 Relaxed Fit Duck Bib Overall
<b>Model #</b>	R01-M
<b>Non-Stock/Mainline Reference</b>	104007
<b>Season</b>	2025 Spring
<b>Development Type</b>	Carryover

<b>Designer</b>	Jillian Schopieray
<b>Product Developer</b>	Carly Wright
<b>Technical Designer</b>	Deana Hunt
<b>Active Colorways</b>	001-Black, 211-Carhartt Brown, 412-Navy, DKB-Dark Brown
<b>Resource</b>	
<b>Product Improvement/Roll Change</b>	Product Improvement

<b>Washed</b>	FR
<b>ANSI</b>	
<b>ATPV</b>	
<b>CAT Rating</b>	EBT

Properties

Department	Men's	Fit	Relaxed Fit
Category	Outerwear		

Documents

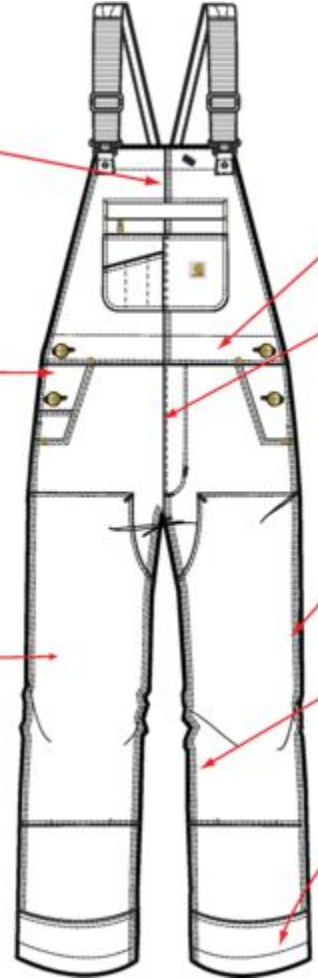
Image	Document Type
 <p><b>BIB:</b></p> <ul style="list-style-type: none"> <li>- Bib Front is 2 ply; interior ply has no CF seam &amp; forms pocket bag for zippered welt pocket. See additional sketch.</li> <li>- Bib top turned back to form 1 1/4" hem, clean finished on interior, 1N lockstitch or chainstitch edgestitched at top and bottom edges.</li> <li>- Keyhole buttonhole in hem, at 45° angle, placed 1/2" over from closest row of CF bib stitching.</li> <li>- Center Front bib seam is 3N Felled.</li> </ul> <p><b>BIB SIDE OPENING:</b></p> <ul style="list-style-type: none"> <li>- 2-button closure at side.</li> <li>- See additional sketch for side construction.</li> </ul> <p><b>CHAP LEG OVERLAY:</b></p> <ul style="list-style-type: none"> <li>- Shell fabric, chap style overlay.</li> <li>- Top and curved edges are clean finished to garment with 1/4" 2N stitching.</li> <li>- 2N Hem bottom edge of overlay before setting overlay to garment. Bottom edge is attached to garment with 2N lockstitch leaving 3 1/4 - 3 3/4" opening at center. Vertical bartacks at both edges of cleanout opening.</li> <li>- Diagonal Bartack at top corner of chap.</li> </ul> <p><b>WAISTBAND:</b></p> <ul style="list-style-type: none"> <li>- Waistband faced with pocketing material, clean finished on interior.</li> <li>- 2N 1/4" topstitch above waist seam, 1N topstitch at top edge of waistband to secure facing.</li> </ul> <p><b>FRONT RISE &amp; ZIPPER FLY:</b></p> <ul style="list-style-type: none"> <li>- Front rise is safety stitched, turned toward wearer's left, and 2NTS.</li> <li>- 1/4" 2 Needle Lockstitch "J" Stitch Fly.</li> <li>- 1 Needle Lockstitch at center front edge of fly.</li> <li>- 1 Bartack at the base of the fly perpendicular to center front, 1 Bartack at the top of the "J" curve, 3/4" above the bartack at the base of the fly.</li> </ul> <p><b>OUTSEAM:</b></p> <ul style="list-style-type: none"> <li>- 5/16" 3-needle Mock Felled, Front over Back.</li> </ul> <p><b>INSEAM:</b></p> <ul style="list-style-type: none"> <li>- 5/16" 3N felled, Front over Back.</li> </ul> <p><b>REINFORCED HEM WITH SELF FABRIC OVERLAY:</b></p> <ul style="list-style-type: none"> <li>- 1/4" 2 Needle Lockstitch kick panel overlay to garment prior to sewing inseam. Overlay extends around leg, inseam to inseam, in one piece.</li> <li>- Hem pant and overlay together in the round with 1N Lockstitch.</li> </ul>	<p>Style Illustrated Details</p>

Displaying 1 - 1 of 12 results

Documents

Image	Document Type
<p><b>STRAPS</b></p> <ul style="list-style-type: none"> <li>- Straps are continuation of panel from back leg. Clean finished at interior.</li> <li>- Horizontal bartack at top overlap point of diamond</li> <li>- Straps are double-turned and clean finished with SN lockstitch.</li> <li>- Strap hems widen at top to encase elastic webbing, see sketch.</li> </ul> <p><b>BACK POCKETS:</b></p> <ul style="list-style-type: none"> <li>- Top hem is clean finished with a 1/4" 2 Needle Lockstitch or Chainstitch</li> <li>- Pocket is fully lined with POCKETING fabric. Pocket reinforcement is held by 1/4" 2 Needle Chainstitch, 3 1/4" from top edge of the pocket.</li> <li>- Pocket edges are clean finished with a 1/4" 2 Needle Lockstitch hem when pocket is set to garment.</li> <li>- Rivets secure pocket opening at the top corners.</li> </ul> <p><b>HAMMER LOOP:</b></p> <ul style="list-style-type: none"> <li>- 2ply self fabric loop, 1 1/8" wide, has 1/4" 2N Lockstitch through center of loop.</li> <li>- Hammer loop is set into side seam at perpendicular angle.</li> <li>- 1 rivet secures Hammer Loop into bottom edge of pocket at top of loop.</li> </ul> <p>Single needle stitch through all layers at top.</p> <p>Strap hems overlap for at least 1" at top of inside strap.</p> <p><b>Interior View: Back diamond</b> Clean finished at interior.</p>	<p>Style Illustrated Details</p>

Displaying 2 - 2 of 12 results

Documents

Image	Document Type
<p><b>TAB DETAIL:</b></p> <p>3/4"</p> <p>1/2"</p> <p>1 1/4"</p> <p>1 1/2"</p> <p><b>BIB STRAPS and BUCKLES:</b></p> <ul style="list-style-type: none"> <li>- Bar and frame strap adjusters.</li> <li>- Trapezoid shaped patch attaches hardware to top of bib. 1N lock-stitch follows trapezoid shape to attach.</li> </ul> <p><b>TAB PLACEMENT:</b></p> <ul style="list-style-type: none"> <li>- Bottom of tab 1" over from edge of bib, on all sizes.</li> </ul>	<p>Style Illustrated Details</p>

Displaying 3 - 3 of 12 results

Documents

Image	Document Type
<p style="text-align: center;">*Measurements apply to all sizes.**</p>	<p>Style Illustrated Details</p>

Displaying 4 - 4 of 12 results

Documents

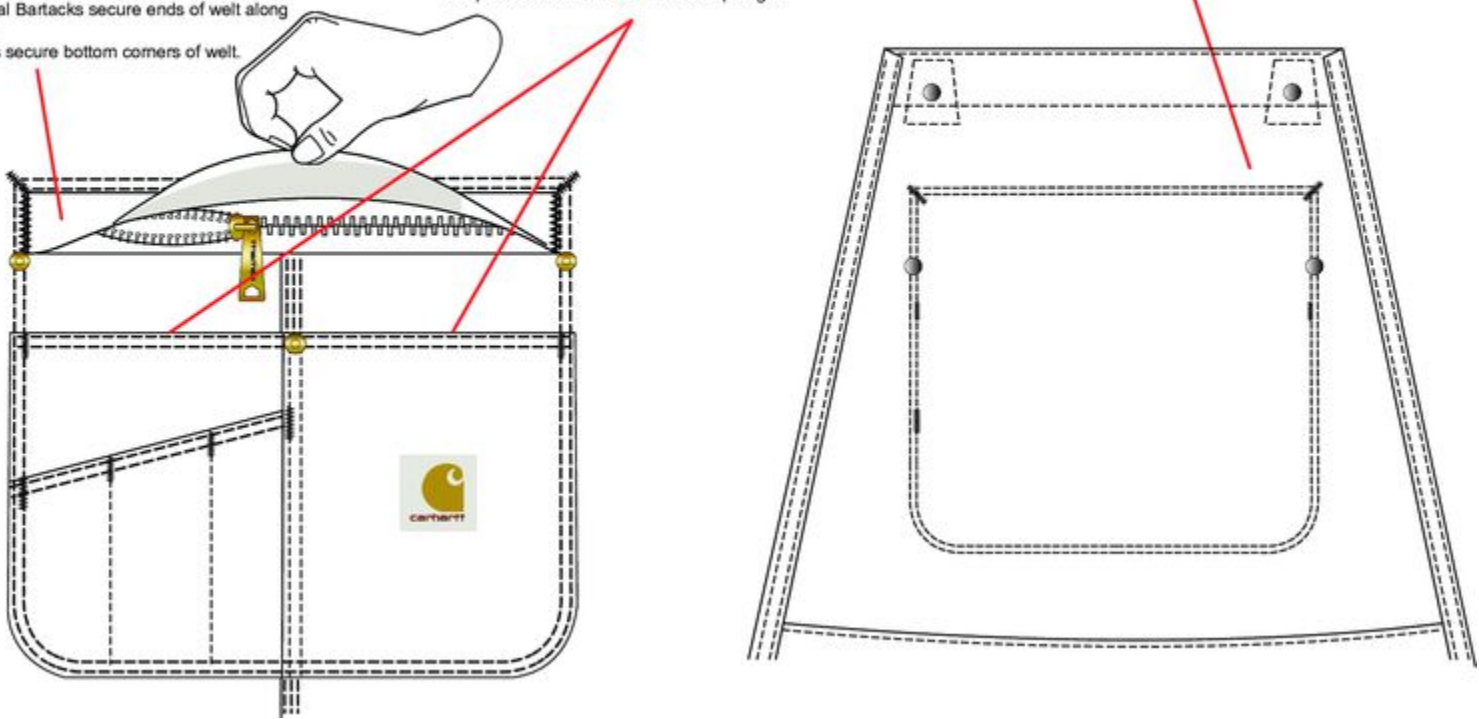
Image	Document Type
<p style="text-align: center;"><b>Bib Chest Pocket Detail</b></p> <div style="display: flex; justify-content: space-between;"> <div style="width: 45%;"> <p><b>Zip Welt Pocket:</b></p> <ul style="list-style-type: none"> <li>- 1 large pocket bag of SHELL FABRIC - (see inside view).</li> <li>- Single welt opens at bottom to reveal zipper closure. Slider at wearer's right when zipped. Zipper extends full width of welt. Zipper opens to pocket bag behind bib.</li> <li>- Diagonal Bartacks at top of welt.</li> <li>- Vertical Bartacks secure ends of welt along length.</li> <li>- Rivets secure bottom corners of welt.</li> </ul> </div> <div style="width: 45%;"> <p><b>Drop-in Bib Pockets:</b></p> <ul style="list-style-type: none"> <li>- 2 drop-in pockets separated by vertical 2N stitching. Angled overlay pen stalls on W's right.</li> <li>- 1/4" 2N hem top pocket &amp; angled pocket.</li> <li>- Vertical bartacks secure edges of all pockets except CF stitch line has 1 rivet at top edge.</li> </ul> </div> </div> <div style="text-align: right; margin-top: 10px;"> <p><b>INSIDE VIEW:</b> Interior ply of shell fabric is stitched through from exterior ply to form pocket bag for zippered welt.</p> </div> 	<p>Style Illustrated Details</p>

Displaying 5 - 5 of 12 results

Documents

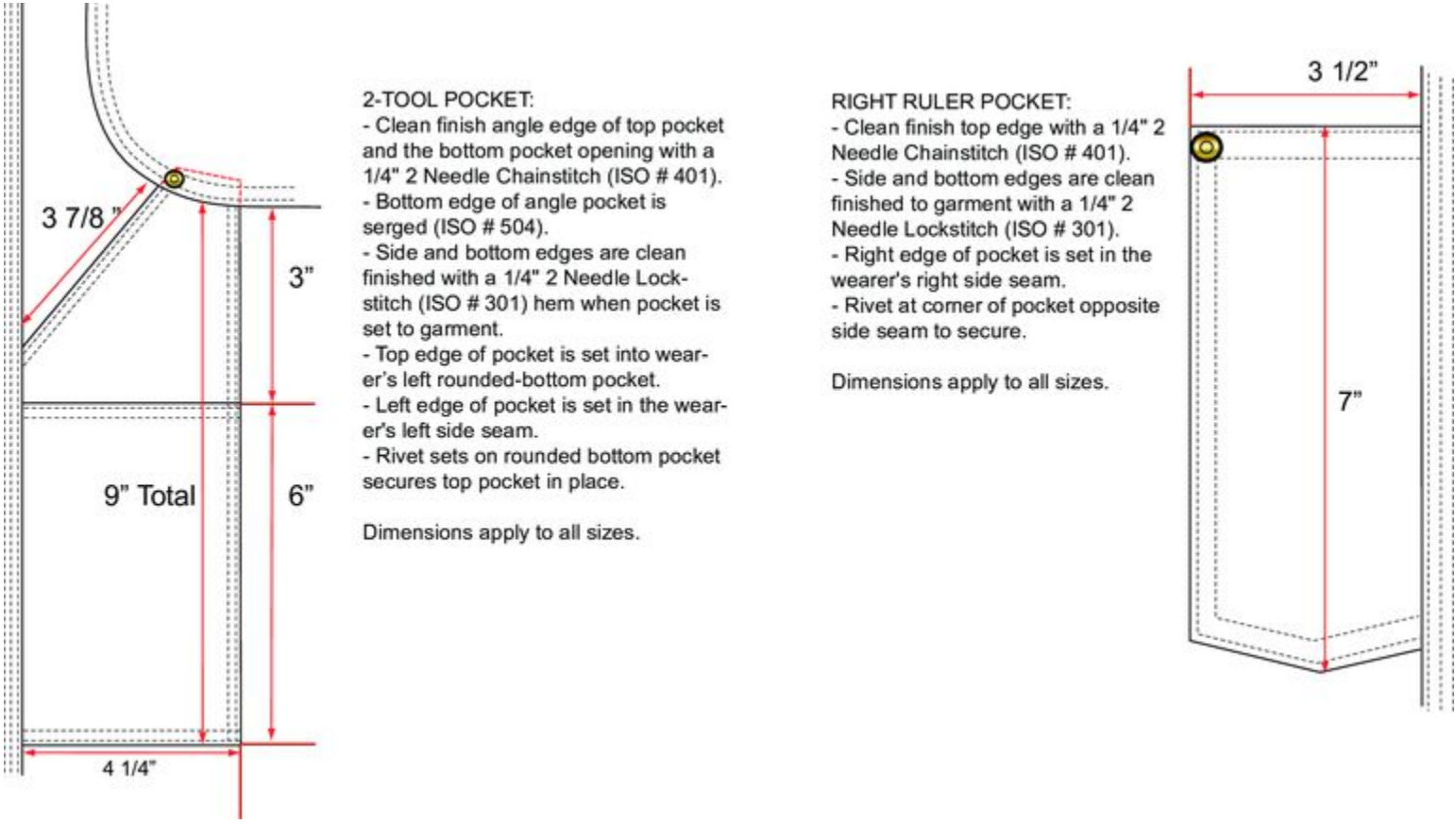
Image	Document Type
 <p><b>2-TOOL POCKET:</b></p> <ul style="list-style-type: none"> <li>- Clean finish angle edge of top pocket and the bottom pocket opening with a 1/4" 2 Needle Chainstitch (ISO # 401).</li> <li>- Bottom edge of angle pocket is serged (ISO # 504).</li> <li>- Side and bottom edges are clean finished with a 1/4" 2 Needle Lockstitch (ISO # 301) hem when pocket is set to garment.</li> <li>- Top edge of pocket is set into wearer's left rounded-bottom pocket.</li> <li>- Left edge of pocket is set in the wearer's left side seam.</li> <li>- Rivet sets on rounded bottom pocket secures top pocket in place.</li> </ul> <p>Dimensions apply to all sizes.</p> <p><b>RIGHT RULER POCKET:</b></p> <ul style="list-style-type: none"> <li>- Clean finish top edge with a 1/4" 2 Needle Chainstitch (ISO # 401).</li> <li>- Side and bottom edges are clean finished to garment with a 1/4" 2 Needle Lockstitch (ISO # 301).</li> <li>- Right edge of pocket is set in the wearer's right side seam.</li> <li>- Rivet at corner of pocket opposite side seam to secure.</li> </ul> <p>Dimensions apply to all sizes.</p>	<p>Style Illustrated Details</p>

Displaying 6 - 6 of 12 results

Documents

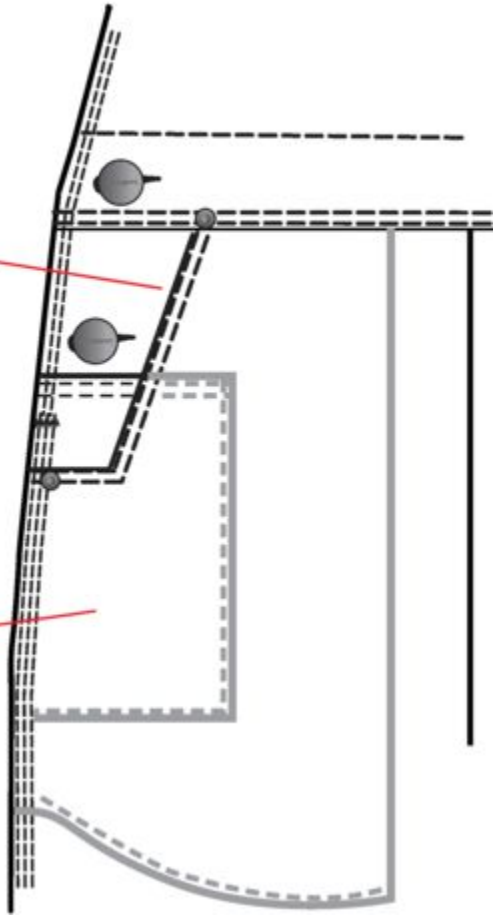
Image	Document Type
<p><b>FRONT LEDGE POCKET:</b></p> <ul style="list-style-type: none"> <li>- Opening edge is finished with 2" wide facing.</li> <li>-Clean finish set facing edge to pocket bag setting with SN lockstitch.</li> <li>-2N lockstitch 1/4" needle spacing pocket opening edge (DO NOT overstretch).</li> <li>- Pocket bearer is serged &amp; topstitched to pocket bag or attached with 2N top coverstitch.</li> <li>- Rivets set at edges of pocket opening: top rivet set just above waist join seam centered between 2N waistband bottom topstitch</li> <li>- Bottom rivet set 1/8" inside side seam stitching; .</li> <li>- Rivets must not break threads.</li> <li>-Pocket bag bottom edge is safety stitched, turned &amp; re-stitched.</li> </ul> <p><b>COIN POCKET</b></p> <ul style="list-style-type: none"> <li>- Clean finish pocket opening with 2N chainstitch.</li> <li>-Bottom &amp; side closest to CF edges of pocket are clean finished &amp; attached to pocket bag with SN lockstitch.</li> <li>-Side of pocket is set into side seam.</li> <li>-Vertical bartack at opening corner closet to CF.</li> <li>**Coin Pocket is the same width at top &amp; bottom edge.**</li> </ul>	<p>Style Illustrated Details</p> 

Displaying 7 - 7 of 12 results





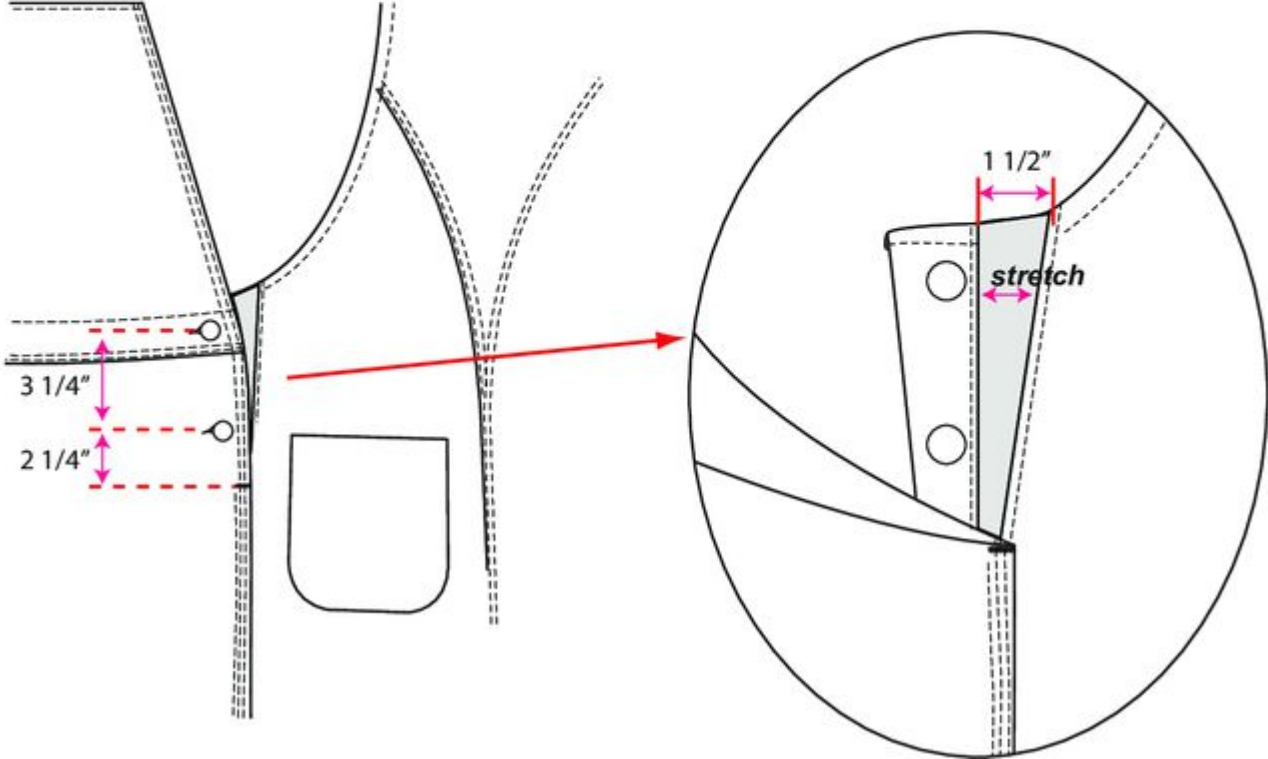















Documents

Image	Document Type
<p><b>BIB SIDE ENTRY:</b></p> <ul style="list-style-type: none"> <li>- 2 button side entry with 2 shank button closures and keyhole buttonholes.</li> <li>- 1st button centered on Waistband. 2nd button 3 1/4" down from the 1st.</li> <li>- Horizontal bartack on outseam 2 1/4" below button-hole.</li> </ul>  <p>The image shows a technical drawing of a bib side entry. On the left, a vertical line represents the side of the bib with two buttonholes. The first buttonhole is centered on the waistband. The second buttonhole is 3 1/4" below the first. A horizontal bartack is located 2 1/4" below the second buttonhole. A red arrow points from the second buttonhole area to a circular inset on the right. This inset shows a detailed view of the stretch panel and underlap, with a dimension of 1 1/2" and the word 'stretch' written across the panel.</p> <p><b>STRETCH PANEL &amp; UNDERLAP:</b></p> <ul style="list-style-type: none"> <li>- 2-ply self fabric underlap bears buttons for SS closure.</li> <li>- Buttons placed accordingly with buttonholes at specified placement.</li> <li>- Stretch panel pieced in between underlap and back bib - allows for give at the waist. 1N edgestitch on underlap and back panel.</li> </ul>	<p>Style Illustrated Details</p>





Displaying 8 - 8 of 12 results

Documents

Image						Document Type
<p><b>ISO Stitch Glossary:</b> Please refer to this as needed for general construction needs</p>						<p>Style Illustrated Details</p>
Top View of Stitching	Bottom View of Stitching	ISO Number	Application	Requirements	Stitch Description	
 Lockstitch		301	Topstitching, SN stitching, Straight stitching	Specify SPI	Stitch created by needle/thread passing through fabric and interlocking with the bobbin's thread. The threads meet at the seam's center. Stitch looks the same top and bottom.	
 Bartack		304	Apparel (Intimate, athletic, infant, exercise, outerwear)	Specify: 1.) SPI 2.) Throw or Width Zig Zag (1/8", 3/16", 1/4")	Stitch is created with a bobbin and needle that are set in the seam's center to form a symmetrical zig-zag pattern. This is also used to identify <b>bartacking</b> and lockstitch buttonsewing/buttonholing.	
 Chainstitch		401	SN chainstitch - Main seams on woven apparel	Specify SPI	Stitch created by SN passing through the fabric and then interlocked with 1 looper thread that is pulled up to the underside of the final seam.	
 3 Thread Overedge		504	SN Overedge Seaming	Specify: 1.) Width Bite (Ex: 1/8", 3/16", 1/4") 2.) SPI	Stitch formed with SN thread and 2 looper threads with the looper threads helping to form a double purl along the edge of the seam for ONLY serging.	
 5 Thread Safetystitch		516	Safety Stitch seaming wovens and knit garments	Specify: 1.) Needle spacing and bite (Ex: 1/8" - 1/89", 3/16" - 3/16", 3/16" - 1/4") 2.) SPI	Combination stitch that consists of SN chainstitch (401) and a 3 thread overedge stitch (504) that are formed at the same time.	
 2N 4 Thread Coverstitch		602	Binding shirts, infant clothing, knitwear, stretch fabrics	Specify: 1.) Needle spacing (Ex: 1/8", 3/16", 1/4") 2.) SPI	Stitch is created with 2N threads, a top cover thread, and a bottom looper thread.	
 3N 5 Thread Coverstitch		605	Lap seaming, cover seaming, binding on knit garments, stretch fabrics	Specify: 1.) Needle spacing (Ex: 1/8", 3/16", 1/4") 2.) SPI	Stitch is created with 3N threads, a top cover thread, and a bottom looper thread.	
 4N 6 Thread Coverstitch		607	Flat or lap seaming knit underwear, fleece, stretch fabrics	Specify SPI	Stitch is created with 4N threads, a top cover thread, and a bottom looper thread. Preferred over 606 stitch due to machines being easier to maintain.	
 Mock Fell Seam	N/A	2.02.03	Sideseams on jeans, trousers, chinos, jackets, etc.	Specify: 1.) Specify seam width 2.) Specify number of needles and needle spacing	N/A	
 Fell Seam	N/A	2.04.06	- Seaming jeans, shirts, jackets, etc. - Generally with a 2n or 3N (401) chainstitch	Specify: 1.) Needle spacing and seam width (Ex: 1/4" needle spacing with 3/8" seam width) 2.) A falling folder with correct capacity required	N/A	

Displaying 9 - 9 of 12 results

Documents

Image	Document Type
<p style="text-align: center;"><b>UNLINED &amp; LINED BIB OVERALLS</b></p> <div style="display: flex; flex-wrap: wrap; justify-content: space-around;"> <div style="text-align: center; margin: 10px;"> <p>1.</p> <p>FRONT</p>  </div> <div style="text-align: center; margin: 10px;"> <p>2.</p> <p>BACK</p>  </div> <div style="text-align: center; margin: 10px;"> <p>3.</p> <p>FOLD IN HALF</p>  </div> <div style="text-align: center; margin: 10px;"> <p>4.</p> <p>FINISHED FOLD</p>  </div> </div> <p style="text-align: center; color: red; font-size: small;">***Please see Packaging Guide for packaging placement and D&amp;C page for polybag requirements</p>	<p>Style Folding Guide Page</p>

Displaying 10 - 10 of 12 results

Documents

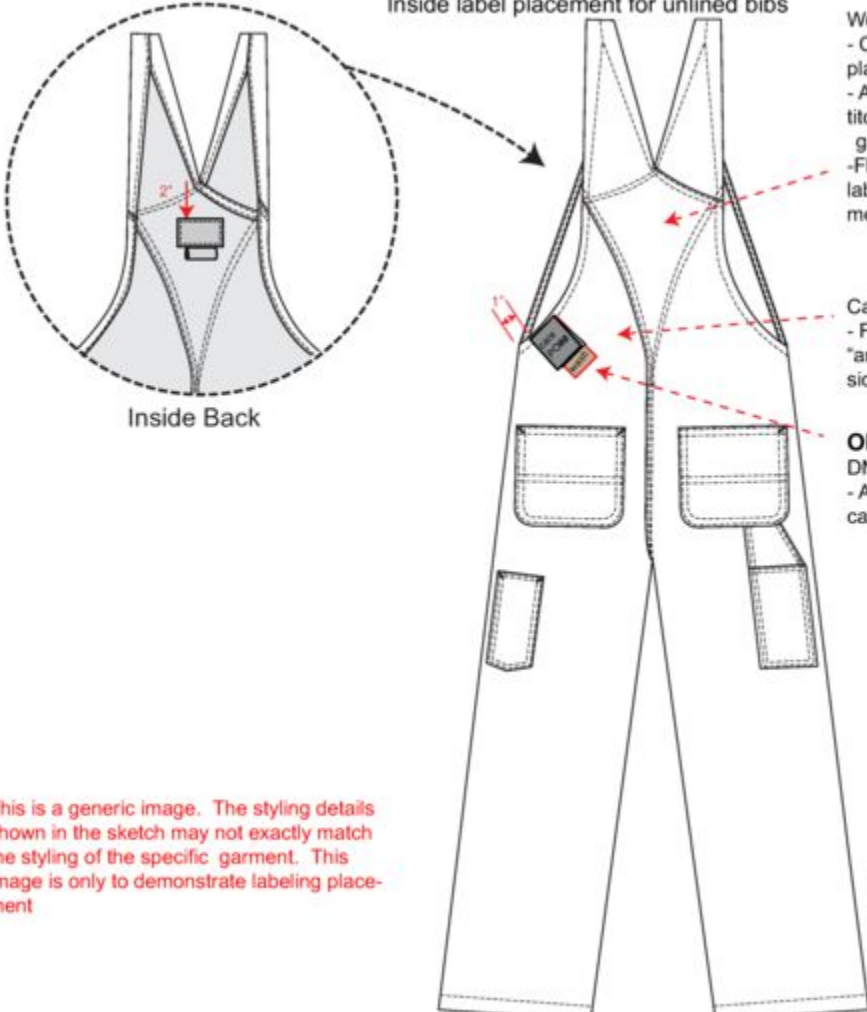
Image	Document Type
<p style="text-align: center;"><b>Inside label placement for unlined bibs</b></p>  <p><b>Woven logo label (on <b>INSIDE</b> of garment):</b></p> <ul style="list-style-type: none"> <li>- Centered on inside back bib diamond, placement as shown in sketch.</li> <li>- Attached on all 4 sides with single needle edges - titch. (Stitching is not visible from outside of garment).</li> <li>- Flag label attached at bottom edge of woven label, centered on width of woven label. Placement must be straight.</li> </ul> <p><b>Care label (on <b>INSIDE</b> of garment):</b></p> <ul style="list-style-type: none"> <li>- Folded edge of label is sewn into back bib "armhole" hem, placement is measured from side opening seam as shown in sketch.</li> </ul> <p><b>ONLY IF REQUIRED ON BOM PAGE:</b> DNY/BLK wash label</p> <ul style="list-style-type: none"> <li>- Attached on <b>INSIDE</b> of garment, underneath care label.</li> </ul> <p><i>This is a generic image. The styling details shown in the sketch may not exactly match the styling of the specific garment. This image is only to demonstrate labeling placement</i></p>	<p>Style Labeling Placement</p>

Displaying 11 - 11 of 12 results

Documents

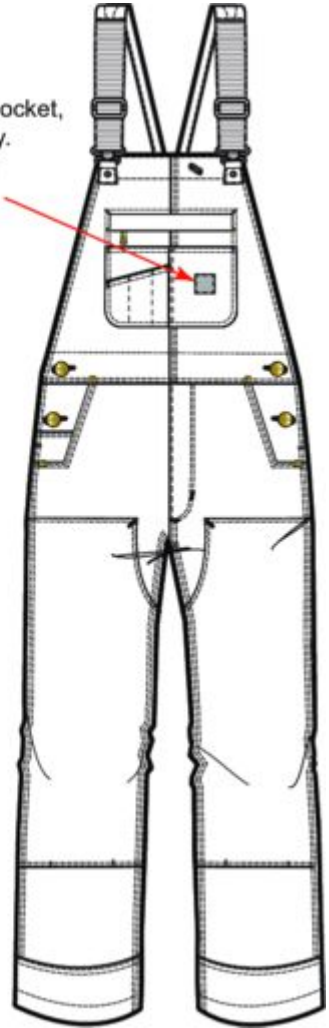
Image	Document Type
<p data-bbox="462 349 892 495"> <b>Logo label</b>            Attached at wearer's left overlay pocket,            centered vertically and horizontally.            All 4 sides sewn down with single            needle edgestitch.         </p>  <p data-bbox="619 1209 745 1274" style="border: 1px solid black; padding: 2px;">last update 8/6/20</p>	<p data-bbox="1585 284 1879 316">Style Labeling Placement</p>

Displaying 12 - 12 of 12 results

Items

Spec Item	Description	Image
Miscellaneous (2)		
Quality Spec- Woven Bibs	<ul style="list-style-type: none"> <li>- No skipped stitches or pleats.</li> <li>- All thread tails clipped to 1/2" or less.</li> <li>- Shell stitches per inch 8 +/-1/2 unless otherwise noted.</li> <li>- All bartacks are 28 or 42 stitches unless otherwise noted.</li> </ul>	
Quality Spec- Woven Bottoms-General	<ul style="list-style-type: none"> <li>- Seams must be free of excessive puckering or pleating.</li> <li>- Seams must be uniform in width.</li> <li>- Stitches per inch must be uniform.</li> <li>- Thread tension and stitch formation must be balanced.</li> <li>- Stitches must not ravel or break.</li> <li>- Loose threads must not be left at ends of seams, or on tacks.</li> <li>- Fabric must not be damaged by foot, feed, or needles.</li> <li>- Shade numbers of components must match.</li> <li>- Garment must be free of soiling or oil spotting.</li> </ul>	
Displaying 1 group and 2 results		

<b>Carhartt Inc.</b>	<b>102776-M R01 RlxdFit Dck Bib Ovrll</b>	<b>102776 Size Chart</b>				<b>Draft-Sample 6/19/24, 10:40 AM</b>					
<b>Company</b>	Carhartt	<b>Description</b>	Starting S24 2D Szie Chart- Unwashed				<b>Base Size</b>	34/32			
<b>Department</b>	Men's	<b>Size Range</b>	2D Men's Numeric Waist x Numeric Inseam				<b>Tolerance</b>	M Alpha & Numeric- Non Bulky			
<b>Season</b>	2025 Spring	<b>Selected Sizes</b>	28-54/28, 28-54/30, 28-54/32, 28-54/34, 28-54/36				<b>Grade Rule</b>	2D Men's Numeric Waist			
<b>Category</b>	Outerwear						<b>Subtype</b>				
<b>Size Chart</b>	102776 Size Chart										

**POMs**

POM	Description	Tol (+)	Tol (-)	Inseam	28	30	32	34	36	38	40	42	44	46	48	50	52	54	
420.01.01	Bib Width - Front - at Top	1/4	-1/4		10 1/8	10 1/4	10 3/8	10 1/2	10 5/8	10 3/4	10 7/8	11	11 1/8	11 1/4	11 3/8	11 1/2	11 5/8	11 3/4	
515.01.02	Waist Extended (Bibs, Coveralls)	1 1/4	-1 1/4		33	35	37	39	41	43	45	47	49	51	53	55	57	59	
525.00	Low Hip - X" from Crotch, Straight Across	3/4	-3/4		40 1/2	42 1/2	44 1/2	46 1/2	48 1/2	50 1/2	52 1/2	54 1/2	56 1/2	58 1/2	60 1/2	62 1/2	64 1/2	66 1/2	
↳ X=4"																			
585.00	Thigh - At Crotch	3/8	-3/8		27	28	29	30	31	32	33	34	35	36	37	38	39	40	
590.00.03	Knee - Straight Leg	3/8	-3/8		20 1/2	21	21 1/2	22	22 1/2	23	23 1/2	24	24 1/2	25	25 1/2	26	26 1/2	27	
595.01.03	Leg Opening - Straight Leg	3/8	-3/8		18 1/4	18 1/2	18 3/4	19	19 1/4	19 1/2	19 3/4	20	20 1/4	20 1/2	20 3/4	21	21 1/4	21 1/2	
615.11	Front Rise - to Waist Join Seam	1/2	-1/2	28	12 3/4	13	13 1/4	13 1/2	13 3/4	14	14 1/4	14 1/2	14 3/4	15	15 1/4	15 1/2	15 3/4	16	
				30	12 3/4	13	13 1/4	13 1/2	13 3/4	14	14 1/4	14 1/2	14 3/4	15	15 1/4	15 1/2	15 3/4	16	
				32	13 1/4	13 1/2	13 3/4	14	14 1/4	14 1/2	14 3/4	15	15 1/4	15 1/2	15 3/4	16	16 1/4	16 1/2	
				34	13 3/4	14	14 1/4	14 1/2	14 3/4	15	15 1/4	15 1/2	15 3/4	16	16 1/4	16 1/2	16 3/4	17	
				36	13 3/4	14	14 1/4	14 1/2	14 3/4	15	15 1/4	15 1/2	15 3/4	16	16 1/4	16 1/2	16 3/4	17	

Displaying 1 - 7 of 36 results

Units: Fractions of inches Grade Rule Display: Absolute

POMs

POM	Description	Tol (+)	Tol (-)	Inseam	28	30	32	34	36	38	40	42	44	46	48	50	52	54		
615.07	Back Rise - Top of Bib	3/4	-3/4	28	26 7/8	27 1/4	27 5/8	28	28 3/8	28 3/4	29 1/8	29 1/2	29 7/8	30 1/4	30 5/8	31	31 3/8	31 3/4		
				30	26 7/8	27 1/4	27 5/8	28	28 3/8	28 3/4	29 1/8	29 1/2	29 7/8	30 1/4	30 5/8	31	31 3/8	31 3/4		
				32	27 7/8	28 1/4	28 5/8	29	29 3/8	29 3/4	30 1/8	30 1/2	30 7/8	31 1/4	31 5/8	32	32 3/8	32 3/4		
				34	28 7/8	29 1/4	29 5/8	30	30 3/8	30 3/4	31 1/8	31 1/2	31 7/8	32 1/4	32 5/8	33	33 3/8	33 3/4		
				36	28 7/8	29 1/4	29 5/8	30	30 3/8	30 3/4	31 1/8	31 1/2	31 7/8	32 1/4	32 5/8	33	33 3/8	33 3/4		
625.00	Inseam (Pants, Bibs, Coveralls)	1/2	-1/2	28	27	27	27	27	27	27	27	27	27	27	27	27	27	27		
				30	29	29	29	29	29	29	29	29	29	29	29	29	29	29	29	
				32	31	31	31	31	31	31	31	31	31	31	31	31	31	31	31	31
				34	33	33	33	33	33	33	33	33	33	33	33	33	33	33	33	33
				36	35	35	35	35	35	35	35	35	35	35	35	35	35	35	35	35
635.01	Waistband Height	1/8	-1/8		1 1/2	1 1/2	1 1/2	1 1/2	1 1/2	1 1/2	1 1/2	1 1/2	1 1/2	1 1/2	1 1/2	1 1/2	1 1/2	1 1/2		
655.01	Fly Stitch Length	1/4	-1/4	28	8 3/4	9	9 1/4	9 1/2	9 3/4	10	10 1/4	10 1/2	10 3/4	11	11 1/4	11 1/2	11 3/4	12		
				30	8 3/4	9	9 1/4	9 1/2	9 3/4	10	10 1/4	10 1/2	10 3/4	11	11 1/4	11 1/2	11 3/4	12		
				32	9	9 1/4	9 1/2	9 3/4	10	10 1/4	10 1/2	10 3/4	11	11 1/4	11 1/2	11 3/4	12	12 1/4		
				34	9 1/4	9 1/2	9 3/4	10	10 1/4	10 1/2	10 3/4	11	11 1/4	11 1/2	11 3/4	12	12 1/4	12 1/2		
				36	9 1/4	9 1/2	9 3/4	10	10 1/4	10 1/2	10 3/4	11	11 1/4	11 1/2	11 3/4	12	12 1/4	12 1/2		
655.03	Fly Width	1/8	-1/8		1 1/2	1 1/2	1 1/2	1 1/2	1 1/2	1 1/2	1 1/2	1 1/2	1 1/2	1 1/2	1 1/2	1 1/2	1 1/2			

Displaying 8 - 12 of 36 results

Units: Fractions of inches Grade Rule Display: Absolute



**POMs**

POM	Description	Tol (+)	Tol (-)	Inseam	28	30	32	34	36	38	40	42	44	46	48	50	52	54	
<b>675.01.01</b>	Bib Length - at Center Front	1/4	-1/4	28	12 7/8	13 1/4	13 5/8	14	14 3/16	14 3/8	14 9/16	14 3/4	14 15/16	15 1/8	15 5/16	15 1/2	15 11/16	15 7/8	
				30	12 7/8	13 1/4	13 5/8	14	14 3/16	14 3/8	14 9/16	14 3/4	14 15/16	15 1/8	15 5/16	15 1/2	15 11/16	15 7/8	
				32	13 1/8	13 1/2	13 7/8	14 1/4	14 7/16	14 5/8	14 13/16	15	15 3/16	15 3/8	15 9/16	15 3/4	15 15/16	16 1/8	
				34	13 3/8	13 3/4	14 1/8	14 1/2	14 11/16	14 7/8	15 1/16	15 1/4	15 7/16	15 5/8	15 13/16	16	16 3/16	16 3/8	
				36	13 3/8	13 3/4	14 1/8	14 1/2	14 11/16	14 7/8	15 1/16	15 1/4	15 7/16	15 5/8	15 13/16	16	16 3/16	16 3/8	
<b>725.00</b>	Hem Height	1/8	-1/8		1	1	1	1	1	1	1	1	1	1	1	1	1	1	
<b>825.00</b>	Knee Placement - from Crotch Seam or Center of Gusset	0	0	28	12	12	12	12	12	12	12	12	12	12	12	12	12	12	
				30	13	13	13	13	13	13	13	13	13	13	13	13	13	13	13
				32	14	14	14	14	14	14	14	14	14	14	14	14	14	14	14
				34	15	15	15	15	15	15	15	15	15	15	15	15	15	15	15
				36	16	16	16	16	16	16	16	16	16	16	16	16	16	16	16
<b>900.03</b>	Strap Turnback	0	0		4	4	4	4	4	4	4	4	4	4	4	4	4	4	
<b>900.01</b>	Strap Total Length (except turnback) - Bibs	1/2	-1/2	28	16	16 1/2	17	17 1/2	17 3/4	18	18 1/4	18 1/2	18 3/4	19	19 1/4	19 1/2	19 3/4	20	
				30	16	16 1/2	17	17 1/2	17 3/4	18	18 1/4	18 1/2	18 3/4	19	19 1/4	19 1/2	19 3/4	20	
				32	16 1/4	16 3/4	17 1/4	17 3/4	18	18 1/4	18 1/2	18 3/4	19	19 1/4	19 1/2	19 3/4	20	20 1/4	
				34	16 1/2	17	17 1/2	18	18 1/4	18 1/2	18 3/4	19	19 1/4	19 1/2	19 3/4	20	20 1/4	20 1/2	
				36	16 1/2	17	17 1/2	18	18 1/4	18 1/2	18 3/4	19	19 1/4	19 1/2	19 3/4	20	20 1/4	20 1/2	
<b>LOWER FRONT POCKETS</b>																			
<b>850.01</b>	Slash Front Pocket Opening Placement - along Waistband	1/4	-1/4		3	3	3	3	3	3	3	3	3	3	3	3	3	3	

Displaying 13 - 19 of 36 results      Units: Fractions of inches    Grade Rule Display: Absolute

POMs

POM	Description	Tol (+)	Tol (-)	Inseam	28	30	32	34	36	38	40	42	44	46	48	50	52	54
850.03	Slash Front Pocket Opening Placement - along Side Seam	1/4	-1/4		6	6	6	6	6	6	6	6	6	6	6	6	6	6
845.05	Slash Pocket Ledge Width - Sideseam Edge to Corner	1/8	-1/8		2	2	2	2	2	2	2	2	2	2	2	2	2	2
955.03	Pocket Bag Width - Front Pant Pocket	1/2	-1/2		6 1/2	7	7	7	7	7	7	7	7	7	7	7	7	7
955.01	Pocket Bag Length - Front Pant Pocket	1/4	-1/4		13	13	13	13	13	13	13	13	13	13	13	13	13	13
837.01	Pocket Placement - Down from Bottom WB- (Watch/Coin)	1/4	-1/4		3 1/2	3 1/2	3 1/2	3 1/2	3 1/2	3 1/2	3 1/2	3 1/2	3 1/2	3 1/2	3 1/2	3 1/2	3 1/2	3 1/2
950.01	Watch/Coin Pocket - Length	1/8	-1/8		5 1/2	5 1/2	5 1/2	5 1/2	5 1/2	5 1/2	5 1/2	5 1/2	5 1/2	5 1/2	5 1/2	5 1/2	5 1/2	5 1/2
950.03	Watch/Coin Pocket - Width	1/8	-1/8		4	4	4 1/2	4 1/2	4 1/2	4 1/2	4 1/2	4 1/2	4 1/2	4 1/2	4 1/2	4 1/2	4 1/2	4 1/2
<b>BACK POKCET</b>																		
855.03.01	Back Pocket Placement - from Side Seam - at Top of Pocket	1/4	-1/4		4 1/2	4 1/2	4 1/2	4 1/2	4 1/2	4 1/2	4 1/2	4 1/2	4 1/2	4 1/2	4 1/2	4 1/2	4 1/2	4 1/2
↳ From bib edge at side seam																		
855.03.01	Back Pocket Placement - from Side Seam - at Top of Pocket	1/4	-1/4		1 1/2	1 3/4	2	2	2	2	2	2	2	2	2	2	2	2
930.01.03	Pocket Length - at Center (Bottoms)	1/8	-1/8		6 1/4	6 1/2	6 3/4	6 3/4	6 3/4	6 3/4	6 3/4	6 3/4	6 3/4	6 3/4	6 3/4	6 3/4	6 3/4	6 3/4
930.03.06	Pocket Width - at Center (Bottoms)	1/8	-1/8		6 1/2	6 3/4	7	7	7	7	7	7	7	7	7	7	7	7

Displaying 20 - 31 of 36 results

Units: Fractions of inches Grade Rule Display: Absolute

POMs

POM	Description	Tol (+)	Tol (-)	Inseam	28	30	32	34	36	38	40	42	44	46	48	50	52	54		
<b>Leg Details</b>																				
965.01	Chap Length - Center	1/2	-1/2	28	20 3/4	21	21 1/4	21 1/2	21 1/2	21 1/2	21 1/2	21 1/2	21 1/2	21 1/2	21 1/2	21 1/2	21 1/2	21 1/2		
				30	22 1/4	22 1/2	22 1/2	22 1/2	22 1/2	22 1/2	22 1/2	22 1/2	22 1/2	22 1/2	22 1/2	22 1/2	22 1/2	22 1/2	22 1/2	
				32	23 3/4	24	24	24	24	24	24	24	24	24	24	24	24	24	24	24
				34	25	25	25	25	25	25	25	25	25	25	25	25	25	25	25	25
				36	26	26	26	26	26	26	26	26	26	26	26	26	26	26	26	26
965.03.01	Chap Width - at Top	1/4	-1/4		6 7/8	7 1/4	7 5/8	8	8 3/8	8 3/4	9 1/8	9 1/2	9 7/8	10 1/4	10 5/8	11	11 3/8	11 3/4		
	Kick Panel Height-Outside	0	0		3	3	3	3	3	3	3	3	3	3	3	3	3	3		
827.07	Chap or Patch Placement - Up from Hem along Side Seam	1/4	-1/4	28	8 1/2	8 1/2	8 1/2	8 1/2	8 1/2	8 1/2	8 1/2	8 1/2	8 1/2	8 1/2	8 1/2	8 1/2	8 1/2	8 1/2		
				30	9	9	9	9	9	9	9	9	9	9	9	9	9	9		
				32	10	10	10	10	10	10	10	10	10	10	10	10	10	10		
				34	11 1/2	11 1/2	11 1/2	11 1/2	11 1/2	11 1/2	11 1/2	11 1/2	11 1/2	11 1/2	11 1/2	11 1/2	11 1/2	11 1/2		
				36	12 1/2	12 1/2	12 1/2	12 1/2	12 1/2	12 1/2	12 1/2	12 1/2	12 1/2	12 1/2	12 1/2	12 1/2	12 1/2	12 1/2		

Displaying 32 - 36 of 36 results

Units: Fractions of inches Grade Rule Display: Absolute

**Style #** 102776  
**Style Description** R01 Relaxed Fit Duck Bib Overall  
**Front\_Sketch** 

**Back\_Sketch**   
**Season** 2025 Spring  
**Department** Men's  
**Category** Outerwear

**Designer** Jillian Schopieray  
**Product Developer** Carly Wright  
**Technical Designer** Deana Hunt  
**Washed**

**Placements**

Code	Product	Material Artwork Description	Supplier Quote	Supplier Code	UOM	Placement	Contractor Supplied	001-Black		211-Carhartt Brown		412-Navy		DKB-Dark Brown	
								Color	Qty by Color	Color	Qty by Color	Color	Qty by Color	Color	Qty by Color
Fabric (2)															
Duck (1)															
DU010	12oz Soft Duck		Vardhman Textiles Ltd.	A108A027 MKPT	yd	Shell Fabric		BLK-Black	2.117	BRN-Carhartt Brown	2.117	NVY2-Navy 2	2.117	DKB-Dark Brown	2.117
Pocketing (1)															
PO010	4.9oz Pocketing - Non-NAFTA Greige		QST Industries - PAK/PAK Natural Colorway	PT230EI-67-NL	yd	Pocketing		NAT-Natural (NL)	0.206	NAT-Natural (NL)	0.206	NAT-Natural (NL)	0.206	NAT-Natural (NL)	0.206
Labels (5)															
Printed Fabric Label (3)															
LA008	Printed Fabric Labels w/Satin Finish	SATIN-Satin	Avery Dennison		yd	Care Label for North America POs only			1		1		1		1

Displaying 1 - 3 of 34 results

**Placements**

Code	Product	Material Artwork Description	Supplier Quote	Supplier Code	UOM	Placement	Contractor Supplied	001-Black		211-Carhartt Brown		412-Navy		DKB-Dark Brown		
								Color	Qty by Color	Color	Qty by Color	Color	Qty by Color	Color	Qty by Color	
LA1038	Printed Fabric Labels w/Double Face Satin Finish & Woven Edge 45mm width	GCLSAT-Global Care Label Cut Singles with woven edge	Avery Dennison		ea	Care Content/PO Season Multi-Language Label. EMEA POs only			1			1			1	
LA050	Printed Fabric Cut Label	PO/Season Label	Factory	Season/PO#	ea	PO #/Season label- stack behind care label - for North America POs only			1			1			1	
<b>Woven Label (2)</b>																
LA1097	Center Back Woven Label with Fit	RELAX - Relaxed Fit Vendor Specifies Size and COO	Avery Dennison		ea	CB Woven label		BLK-Black	1	BLK-Black	1	BLK-Black	1	BLK-Black	1	1
LA1237	Woven Label	CA5-#5 Woven Label 40mm x 40mm	Avery Dennison		ea	Woven logo label at garment exterior - chest			1			1			1	1
<b>Packaging (6)</b>																
<b>Matchbook (1)</b>																
Displaying 4 - 7 of 34 results																

**Placements**

Code	Product	Material Artwork Description	Supplier Quote	Supplier Code	UOM	Placement	Contractor Supplied	001-Black		211-Carhartt Brown		412-Navy		DKB-Dark Brown	
								Color	Qty by Color	Color	Qty by Color	Color	Qty by Color	Color	Qty by Color
LA1088	Pocket Rider	102776-Relaxed Fit Duck Bib Overall	Avery Dennison		ea	pocket rider			1		1		1		1
Miscellaneous-Packaging (1)															
601027	Bib Strap Size Label w Adhesive Back	USUAL21-Non Insulated 'BUY YOUR USUAL PANT SIZE' SP'21	Avery Dennison		ea	bib strap label			1		1		1		1
Polybag (1)															
PB002	Single Pack Polybag with Suffocation Warning	Single Pack Polybag with Suffocation Warning	Factory	CLR LLDPE BAG	ea	Polybag should fit fold size garment, carton size, and standard case quantity		CLR-Clear	1	CLR-Clear	1	CLR-Clear	1	CLR-Clear	1
Sticker (1)															
SK1052	Horizontal RFID Enabled UPC Sticker Blanks	RFID - Enabled UPC Sticker for Bottoms/Outerwear Styles	Avery Dennison		ea	UPC Sticker			1		1		1		1
Swiftack/Packaging Attachment (2)															
FA005	1" Swiftach Fastener	1" Swiftach Fastener	Factory		ea	swift attach		BLK-Black	1	BLK-Black	1	BLK-Black	1	BLK-Black	1
FA008	1/2" Plastic Swiftack Staple		Factory		ea	plastic staples		CLR-Clear	2	CLR-Clear	2	CLR-Clear	2	CLR-Clear	2
Trim (21)															
Bar (1)															
Displaying 8 - 13 of 34 results															

**Placements**

Code	Product	Material Artwork Description	Supplier Quote	Supplier Code	UOM	Placement	Contractor Supplied	001-Black		211-Carhartt Brown		412-Navy		DKB-Dark Brown	
								Color	Qty by Color	Color	Qty by Color	Color	Qty by Color	Color	Qty by Color
600132	1 3/4" Bib Hardware Bar		SX Industries	BA-40103-2400	ea	Bar for strap		BRS-Brass	2	BRS-Brass	2	BRS-Brass	2	BRS-Brass	2
Burr (1)															
BR023	13L Non-Logo 2-Prong Fastener Burr		YKK Snap Fasteners America Inc	523-0000	ea	Rivets at bib & double front pocket corners		BRS-Brass (345)	16	BRS-Brass (345)	16	BRS-Brass (345)	16	BRS-Brass (345)	16
Buttons (1)															
600575	30L Logo Shank Button		YKK Snap Fasteners America Inc	GC1-S315-GE2	ea	Buttons for side adjustment		BRS-Brass (GC1-S315-347)	4	BRS-Brass (GC1-S315-347)	4	BRS-Brass (GC1-S315-347)	4	BRS-Brass (GC1-S315-347)	4
Elastic (1)															
EL1031	1 5/8" Elastic Suspender Strap		AEC Narrow Fabrics	163-8194 Asian Sample	yd	Suspender webbing		N235-Black 235		B456-Brown 456		I247-Blue 247		B456-Brown 456	
Eye (1)															
HE1000	Thicker Gauge Bib Eye		SX Industries	BK-40103B	ea	Bib hardware eye		BRS-Brass (2400)	2	BRS-Brass (2400)	2	BRS-Brass (2400)	2	BRS-Brass (2400)	2
Fasteners (2)															
Displaying 14 - 18 of 34 results															

**Placements**

Code	Product	Material Artwork Description	Supplier Quote	Supplier Code	UOM	Placement	Contractor Supplied	001-Black		211-Carhartt Brown		412-Navy		DKB-Dark Brown	
								Color	Qty by Color	Color	Qty by Color	Color	Qty by Color	Color	Qty by Color
FA002	Metal Standard Shank Button Fastener		YKK Snap Fasteners America Inc	A26P664301B/14	ea	button fastener		ALU-Aluminum (301)	4	ALU-Aluminum (301)	4	ALU-Aluminum (301)	4	ALU-Aluminum (301)	4
FA040	2-Prong Steel Base Burr Fastener		YKK Snap Fasteners America Inc	W82-P683-340	ea	Rivet fastener		STL-Steel (340)	16	STL-Steel (340)	16	STL-Steel (340)	16	STL-Steel (340)	16
Frame (1)															
600131	1 3/4" Bib Hardware Frame		SX Industries	RN-40102-2400	ea	Frame for strap		BRS-Brass	2	BRS-Brass	2	BRS-Brass	2	BRS-Brass	2
Hook (1)															
HO1000	Thicker Gauge Logo'd Bib Hook		SX Industries	BK-40101B	ea	Bib hardware hook		BRS-Brass (2400)	2	BRS-Brass (2400)	2	BRS-Brass (2400)	2	BRS-Brass (2400)	2
Thread (9)															
TH010	T-60 Core Spun Cotton Wrapped Thread		American & Efird Inc.	T-60 D-Core	yd	looper		*MAT*-Matching		*MAT*-Matching		*MAT*-Matching		*MAT*-Matching	
TH010	T-60 Core Spun Cotton Wrapped Thread		American & Efird Inc.	T-60 D-Core	yd	label attach		SLV-Silver (W32020)		SLV-Silver (W32020)		SLV-Silver (W32020)		SLV-Silver (W32020)	

Displaying 19 - 24 of 34 results



**Placements**

Code	Product	Material Artwork Description	Supplier Quote	Supplier Code	UOM	Placement	Contractor Supplied	001-Black		211-Carhartt Brown		412-Navy		DKB-Dark Brown	
								Color	Qty by Color	Color	Qty by Color	Color	Qty by Color	Color	Qty by Color
TH006	T-60 Poly Core Poly Wrapped Thread		American & Efird Inc.	T-60 Perma Core	yd	pocket bag thread		*MAT*-Matching		*MAT*-Matching		*MAT*-Matching		*MAT*-Matching	
TH010	T-60 Core Spun Cotton Wrapped Thread		American & Efird Inc.	T-60 D-Core	yd	main topstitching		*MAT*-Matching		*MAT*-Matching		*MAT*-Matching		*MAT*-Matching	
TH015	T-35 Textured Polyester Thread		American & Efird Inc.	T-35 Wildcat	yd	overlock		*MAT*-Matching		*MAT*-Matching		*MAT*-Matching		*MAT*-Matching	
TH140	T-40 Poly Core Poly Wrapped Thread		American & Efird Inc.	T-40 Perma Core	yd	bobbin/looper		*MAT*-Matching		*MAT*-Matching		*MAT*-Matching		*MAT*-Matching	
TH018	T-45 Air Entangled Polyester Thread		American & Efird Inc.	T-45 MAGIC	yd	looper		*MAT*-Matching		*MAT*-Matching		*MAT*-Matching		*MAT*-Matching	
TH015	T-35 Textured Polyester Thread		American & Efird Inc.	T-35 Wildcat	yd	pocket overlock		*MAT*-Matching		*MAT*-Matching		*MAT*-Matching		*MAT*-Matching	
TH033	T-180 Cotton Thread		American & Efird Inc.	T-180 Anecot Soft	yd	button hole gimp		*MAT*-Matching		*MAT*-Matching		MAT-Matching		*MAT*-Matching	

Trim Fabric (1)

Displaying 25 - 31 of 34 results

**Placements**

Code	Product	Material Artwork Description	Supplier Quote	Supplier Code	UOM	Placement	Contractor Supplied	001-Black		211-Carhartt Brown		412-Navy		DKB-Dark Brown	
								Color	Qty by Color	Color	Qty by Color	Color	Qty by Color	Color	Qty by Color
600741	7" Knit Elastic Stretch Panel		AEC Narrow Fabrics	AEC3800	yd	Elastic at side adjustment		BLK-Black		BRN-Carhartt Brown		NVY-Navy		DKB-Dark Brown	
Zipper (2)															
ZP129	#5 Brass Bottom Zipper w GSN6 Pull		YKK Zippers Asia	RGC-59GSN6 J	ea	Fly zipper		*MAT*- Matching	1	*MAT*- Matching	1	*MAT*- Matching	1	*MAT*- Matching	1
600804	#8 Nylon Coil CE Zipper w Brass Swing Logo Pull		YKK Zippers Asia	CFC-86 DACAR35 O	ea	Pocket bib zipper		*MAT*- Matching	1	*MAT*- Matching	1	*MAT*- Matching	1	*MAT*- Matching	1

Displaying 32 - 34 of 34 results

**Composition**

- 100% Cotton
- (1) Shell
- ✓
- 12oz Soft Duck

**Care Instructions**

---

Care Label	Description	Care Type
Care Label D	Exclusive Trimming, Machine Wash Cold Like Colors, Non-Chlorine Bleach, Tumble Dry Low, Do Not Use Fabric Softeners, Cool Iron, Do Not Dry Clean	All Care
Displaying 1 result		